

# CEILING & WALL GUIDE



Armstrong®  
Ceilings



**VIEW &  
BOOKMARK  
OUR DIGITAL  
CATALOG!**  
See inside cover  
for details.

## TOOLS YOU CAN USE

**WEBSITE:** [ceilings.com/canada](https://ceilings.com/canada)

**DIGITAL CATALOG:**  [www.armstrongceilings.com/resdcatalog-en-ca.html](https://www.armstrongceilings.com/resdcatalog-en-ca.html)

**WEB TOOLS:**  **Ceiling Project Estimator**  
[ceilings.com/projectestimatorca](https://ceilings.com/projectestimatorca)

 **Drop Ceiling Calculator**  
[ceilings.com/calculatorca](https://ceilings.com/calculatorca)

 **Ceiling Selector**  
[ceilings.com/selectorca](https://ceilings.com/selectorca)

 **Ceiling Replacement Finder**  
[ceilings.com/IDMyCeilingca](https://ceilings.com/IDMyCeilingca)

**INSPIRATION:** **Photo Gallery**  
[ceilings.com/photosca](https://ceilings.com/photosca)

**Look Book**  
[ceilings.com/lookbook](https://ceilings.com/lookbook)

**INSTALLATION AND VIDEOS:**  [ceilings.com/installationca](https://ceilings.com/installationca)  
[ceilings.com/videosca](https://ceilings.com/videosca)

**WARRANTIES:** [ceilings.com/warrantyca](https://ceilings.com/warrantyca) or contact  
[techline@armstrongceilings.com](mailto:techline@armstrongceilings.com)

**TECHLINE:** 1-877-ARMSTRONG (276-7876)  
[techline@armstrongceilings.com](mailto:techline@armstrongceilings.com)





# TABLE OF CONTENTS

Getting Started	1-2
Wood Look—Surface Mount (Direct Apply) Ceilings	3-10
Wood Look—Walls	7
PVC Plastic—Suspended (Drop) or Surface Mount (Direct Apply) Ceilings	11-16
Decorative Look—Suspended (Drop) Ceilings	17-19
Smooth Look—Suspended (Drop) Ceilings	20-25
Textured Look—Suspended (Drop) Ceilings	26-33
12-in × 12-in—Surface Mount (Direct Apply) Ceilings	34-36
24-in × 48-in—Surface Mount (Direct Apply) Ceilings	37-39
Installation—Suspended (Drop) Ceilings	40-48
Installation—Drywall Grid Products	49-50
Installation—Surface Mount (Direct Apply) Ceilings	51-52
Installation—WoodHaven™ Planks Surface Mount (Direct Apply) Ceilings	53
Product Comparison Data	54
Performance and Installation Method Guide by Item	55
Packaging Guide by Item	56

# GETTING STARTED WITH CEILINGS

## 1 HOW IT INSTALLS

Attachment Method	Benefits	Installation Method	Sizes Available
Suspended (Drop)	 Get access behind panels	Metal grid system and hanging hardware	24-in × 24-in 24-in × 48-in
Surface Mount (Direct Apply)	 Maximize ceiling height	Easy Up® Installation System (12 × 12 tiles, 6 × 48 and 5 × 84 planks); All-in-one Self-stop Fastener or Truss Mounting Kit (24 × 48 AcoustAffix® panels); or Adhesive (12 × 12 tiles, 6 × 48 planks, 24 × 48 AcoustAffix® panels)	12-in × 12-in 6-in × 48-in 5-in × 84-in 24-in × 48-in

## 2 CHOOSE A LOOK

### DESIGNER



Wood Look



PVC Plastic

### SUSPENDED (DROP) CEILINGS



Decorative Look

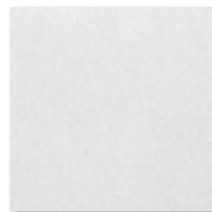

Smooth Look



Textured Look

### Edge detail impacts overall look



no visible grid  
tongue & groove



visible grid  
square edge



minimizes grid look  
regular edge

### SURFACE MOUNT (DIRECT APPLY) CEILINGS



12-in × 12-in Surface Mount (Direct Apply)

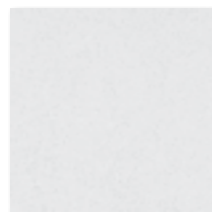

24-in × 48-in Surface Mount (Direct Apply)

### 3 CONSIDER PERFORMANCE FEATURES



**Sag/Humidity Resistance:** Products with this icon have superior performance and maintain a flat, attractive ceiling surface in areas of up to 90% humidity; use in spaces that are not climate controlled

**Standard Performance:** appropriate for climate controlled spaces

**Superior Performance:** appropriate for non-climate controlled interior spaces



**Noise Reducing:** Products with this icon reduce noise within a room or traveling from room to room

**NRC:** reduces noise within a room, the higher the number, the better the performance

**CAC:** blocks sound between rooms, the higher the number, the better the performance



**Mold/Mildew Resistance:** Products with this icon have superior performance and resist the growth of mold and mildew on the treated surface

**Standard Performance:** appropriate for climate controlled spaces

**Superior Performance:** appropriate for non-climate controlled interior spaces



**Fire Resistance:** Products with this icon meet building codes for commercial and residential spaces, based on E-84 testing

All ceiling products meet or exceed residential fire or safety codes

### DISINFECTABILITY AND CLEANABILITY



**Disinfect by Fogging:** Products with this icon may be fogged following CDC recommendations using EPA-approved disinfectant cleaners per Armstrong Disinfecting Guidelines.



**Disinfect by Wiping:** Products with this icon may be wiped following CDC recommendations using EPA disinfectant cleaners per Armstrong Disinfecting Guidelines.



**Disinfect by Spraying:** Products with this icon may be sprayed following CDC recommendations using EPA disinfectant cleaners per Armstrong Disinfecting Guidelines.

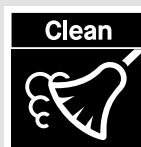

**Cleanable:** The majority of Armstrong® Ceiling and Grid products can be cleaned using one or more methods\*.

NOTE: See Disinfecting Guidelines on [ceilings.com/cleanmyceilingca](http://ceilings.com/cleanmyceilingca) for recommended disinfecting methods and disinfectants.  
 \* General Cleaning Guidelines for most products, including recommended cleaning methods and cleaners, are also available on [ceilings.com/cleanmyceilingca](http://ceilings.com/cleanmyceilingca).



1149 WOODHAVEN™ BEADBOARD (CEILING)

**WoodHaven™**  
CEILING & WALL PLANKS



## WOODHAVEN™ CEILING PLANKS

Our 5-in × 84-in WoodHaven™ ceiling planks offer a range of finishes for every room, are made of MDF (medium density fiberboard) and can be installed in three different ways.

### CEILING FINISHES

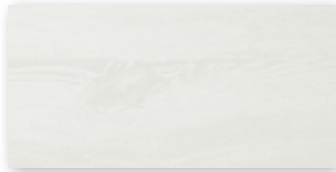

1140 CLASSIC WHITE

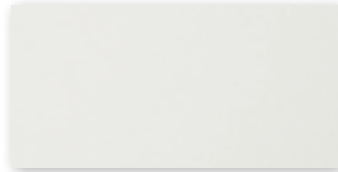

1148 PAINTED WHITE

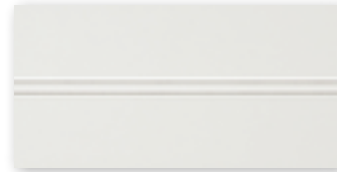

1149 BEADBOARD

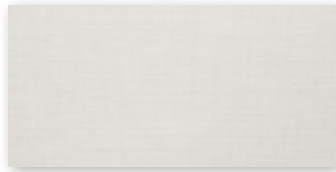

1138 WOVEN WHITE



1275 COASTAL WHITE



1276 DRIFTWOOD GRAY



1139 WOVEN CHARCOAL GRAY



1273 WEATHERED



1265 WHITE WASH



1261 NATURAL MAPLE



1262 CLASSIC MAPLE



1263 NEW APPLE



1271 BAMBOO

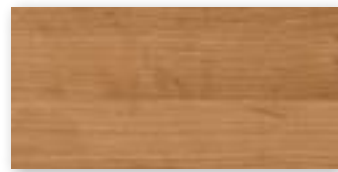

1268 NATURAL CHERRY













1264 RUSTIC PINE

**WoodHaven™**  
CEILING & WALL PLANKS

## FEATURES & BENEFITS

- Prefinished; no sanding, staining or sealing
- Great for covering damaged drywall, plaster or popcorn ceilings
- Easy retrofit option to cover old basement ceiling grid
- Update the look of your ceiling without losing ceiling height
- Items #1148 and 1149 are paintable
- Beveled tongue and groove edge minimizes the appearance of gaps during normal expansion and contraction
- Staggered installation means minimal waste
- See page 7 for information on how WoodHaven™ planks can be used on walls

## PRODUCT SPECIFICATIONS

Item #	Edge Detail	Dimensions (Inches)	Install System	Noise Reducing NRC/CAC	Sag Resistance	Mold Resistance	Light Reflectance	Fire Resistance	SF Per Ctn	Pcs/Ctn	Material Type
1148 & 1149	 Beveled Tongue & Groove	5 × 84 × 3/8	Surface Mount (Direct Apply)	 -/-	 Standard	 Standard	0.85	 Class C	29	10	MDF
All Other Item #s	 Beveled Tongue & Groove	5 × 84 × 3/8	Surface Mount (Direct Apply)	 -/-	 Standard	 Standard	-	 Class C	29	10	MDF



1140 WOODHAVEN™ CLASSIC WHITE (WALL)





## INSTALL WOODHAVEN™ CEILINGS IN THREE DIFFERENT WAYS



Before starting your project, review complete installation instructions at [ceilings.com/installwoodhavenca](https://ceilings.com/installwoodhavenca) for important design and installation considerations.

### 1 CLIPS AND SCREWS



Installation clips and screws (55 each) are included in the plank package and install directly to furring strips (sold separately). This installation method is suitable for ceilings with a greater than 10 degree slope. Please contact Techline at 1-877-ARMSTRONG (276-7876) for guidance on how to install planks on a sloped ceiling.

### 2 EASY UP® TRACKS AND CLIPS



The Easy Up® installation system is fast and easy with snap-on (vs. screw-in) clips, and is the recommended method to install planks over drywall, plaster or popcorn ceilings. Use the Easy Up® installation system for ceilings with a less than 10 degree slope.

Item #1190 (20 tracks per carton)

Item #1191 (360 clips per carton—8 bags of 45 each) or Item #1191SC (135 clips per carton)

NOTE: Both track products and clip accessories are required for a complete Easy Up system and must be used together. Items are sold separately.

### 3 RETROFIT 15/16-in GRID

Transform an existing 15/16-in suspended (drop) ceiling using Easy Up® clips and WoodHaven™ planks.



Remove panels



Snap on Easy Up clips

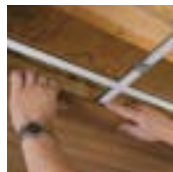

Position planks; slide and secure clips

NOTE: Existing grid must be 15/16-in. Easy Up clips (sold separately) must be used for the retrofit installation. Screws and clips included in the WoodHaven package are only used where grid intersections interfere with the installation of an Easy Up clip.

Visit [ceilings.com/projectestimatorca](https://ceilings.com/projectestimatorca) to access our online material estimator.

Visit [ceilings.com/installwoodhavenca](https://ceilings.com/installwoodhavenca) for full installation instructions, tips and design/space considerations.



For installation videos, please visit [ceilings.com/videosca](https://ceilings.com/videosca).



1138 WOODHAVEN™ WOVEN WHITE (CEILING)

**WoodHaven™**  
CEILING & WALL PLANKS

# WOODHAVEN™ PLANKS ON WALLS

Consider the expanded range of decorating options with WoodHaven™ planks used on walls. Five design finishes — 1140 Classic White, 1148 Painted White, 1149 Beadboard, 1138 Woven White and 1139 Woven Charcoal Gray — are recommended for high-traffic areas. For other finishes, care must be taken to avoid scratching of surface in high-traffic areas.

## HIGH-TRAFFIC WALL FINISHES



1140 CLASSIC WHITE

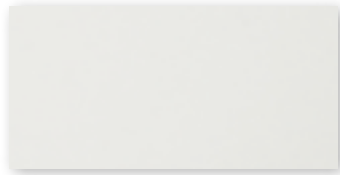

1148 PAINTED WHITE

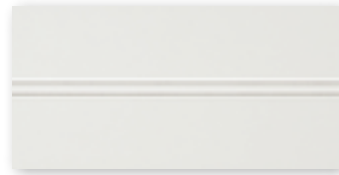

1149 BEADBOARD



1138 WOVEN WHITE

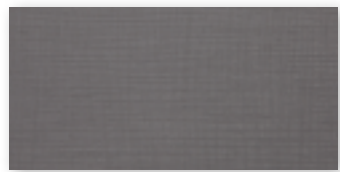

1139 WOVEN CHARCOAL GRAY

## FEATURES & BENEFITS

- Easy installation on walls: vertically with construction adhesive or horizontally with included clips
- All finishes can be used on walls; however, items #1140, 1148, 1149, 1138 and 1139 are recommended for high-traffic areas
- High-traffic finishes have a durable surface that is easily touched up if damaged
- Items #1148 and 1149 are paintable to match your interior

## WALL INSTALLATION OPTIONS

With either option, finish with a trim of your choice.

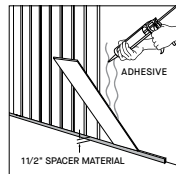

Install vertically on a wall using construction adhesive. Follow the adhesive manufacturer's recommendations for surface preparation and application rate. Use painter's tape if necessary to hold planks in place until the adhesive sets up.

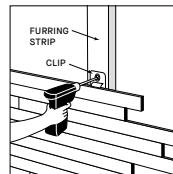

Install horizontally on a wall using clips included in the WoodHaven plank carton.



For installation videos, please visit [ceilings.com/videosca](http://ceilings.com/videosca).



1139 WOVEN CHARCOAL GRAY (HEADBOARD)



1148 PAINTED WHITE (WALL)



1149 BEADBOARD (WALL)



1138 WOVEN WHITE (WALL)

For installation instructions, please visit [ceilings.com/installwoodwalls](http://ceilings.com/installwoodwalls).



WOOD LOOK



SURFACE MOUNT (DIRECT APPLY) CEILINGS

480 COUNTRY CLASSIC™ PLANK WHITE (CEILING) AND 1149 WOODHAVEN™ BEADBOARD (WALL)

WoodLook

# COUNTRY CLASSIC™ PLANK

The visual of our 6-in × 48-in Country Classic™ Plank provides a beautiful country rustic look as a cost-effective alternative to real wood planks. These easy-to-install mineral fiber ceiling planks are lightweight and easily cut with a utility knife. Available in white and 3 colors.

## CEILING FINISHES

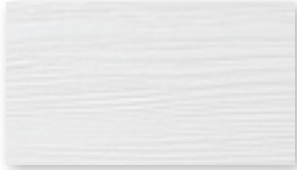

480 COUNTRY CLASSIC™ PLANK WHITE



480LG COUNTRY CLASSIC™ PLANK LIGHT GRAY



480LB COUNTRY CLASSIC™ PLANK LIGHT BEIGE



480MB COUNTRY CLASSIC™ PLANK MEDIUM BEIGE

## FEATURES & BENEFITS

- Made of mineral fiber (similar material to standard ceiling products)
- Real wood-grain appearance at an affordable price
- White finish is paintable or stainable to match any décor
- Great for covering damaged drywall, plaster or popcorn ceilings

## PRODUCT SPECIFICATIONS

Item #	Edge Detail	Dimensions (Inches)	Install System	Noise Reducing NRC/CAC	Sag Resistance	Mold Resistance	Light Reflectance	Fire Resistance	SF Per Ctn	Pcs/Ctn	Material Type
480 (White)	Beveled Tongue & Groove	6 × 48 × 1/2	Easy Up®	-/30	Standard	Standard	0.80	Class A	40	20	Mineral Fiber
480LG, 480LB, 480MB	Beveled Tongue & Groove	6 × 48 × 1/2	Easy Up®	-/30	Standard	Standard	-	Class A	40	20	Mineral Fiber

## INSTALLATION SYSTEM

- Tongue & groove products have no visible grid
- Easy Up® installation system or adhesive

See pages 51 and 52 for additional information.

For installation instructions, please visit [ceilings.com/installcountryclassic](http://ceilings.com/installcountryclassic)

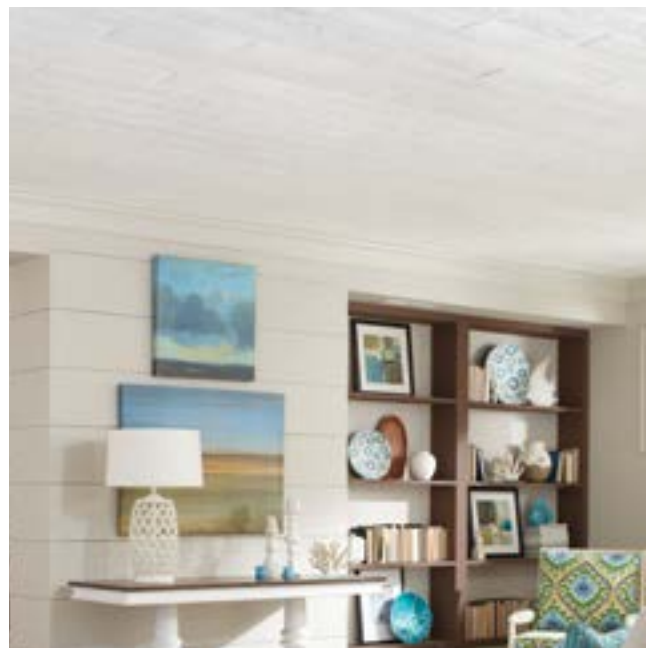

480 COUNTRY CLASSIC™ PLANK WHITE (CEILING)

**WoodLook**



480LG COUNTRY CLASSIC™ PLANK LIGHT GRAY



480LB COUNTRY CLASSIC™ PLANK LIGHT BEIGE

## HOW TO STAIN YOUR COUNTRY CLASSIC™ PLANK WHITE CEILING

### ADD WARMTH TO A FAMILY ROOM OR CHARM TO A KITCHEN

There's nothing like the rustic look of wood. Our Country Classic™ planks give you the look of wood without the expense. Using a water-based gel stain on the white finish planks, choose a light, medium, or dark color that complements the look and feel of your room.

Here's how:

**Step 1** Select and test the stain color—light to dark to ensure the color of stain you choose complements your room. You may also use a water based paint and mix with an acrylic glaze finish to achieve the same wood look. Mix together 1 part paint and 6 parts glaze for a light-to-medium tone, or 1 part paint to 4 parts glaze for a darker tone.

**Step 2** Stain planks—follow the manufacturer's instructions for applying the stain. For a darker stain, apply two coats, waiting 24 hours between coats and until dry.

**Step 3** Install the planks; follow the installation instructions found in the carton.

**NOTE:** Armstrong Ceilings cannot guarantee that the published surface burning characteristics, fire resistance ratings, acoustical performance, dimensional stability/sag, or light reflectance will remain the same after repainting. Field painting or staining will void the warranty.



BEFORE: 480 COUNTRY CLASSIC™ PLANK WHITE



AFTER: 480 COUNTRY CLASSIC™ PLANK WHITE (FIELD STAINED)



1280BXA EASY ELEGANCE™ DEEP COFFER WHITE WITH 1278 FLAT WHITE BORDER (CEILING)

**EasyElegance™**  
PVC PLASTIC CEILINGS



# EASY ELEGANCE™ COFFERED CEILING PANELS

Armstrong® Easy Elegance™ Coffered ceiling panels are made of rigid PVC plastic and are available in both deep and shallow options. Panels offer moisture, mold and mildew resistance and are maintenance-free.

## STYLES



1280BXA EASY ELEGANCE™  
DEEP COFFER WHITE



1280BLBXA EASY ELEGANCE™  
DEEP COFFER BLACK



1282BXA EASY ELEGANCE™  
SHALLOW COFFER WHITE



1282BLBXA EASY ELEGANCE™  
SHALLOW COFFER BLACK



SIDE VIEW

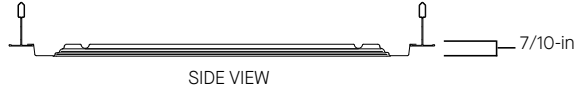

SIDE VIEW



1280BLBXA EASY ELEGANCE™ DEEP COFFER BLACK (CEILING)

## FEATURES & BENEFITS

- Made of lightweight PVC (plastic)
- Sophisticated coffer look at a fraction of the cost of custom work
- Sag resistance
- Drywall perimeter border recommended for a high-end finished look
- Easy Elegance™ Flat panels and Textured panels can also be used as a perimeter border; see next pages for details
- For residential use only
- Easy installation system provides access to pipes, ducts and wiring

For additional details about perimeter borders, visit [ceilings.com/coffersfaqca](http://ceilings.com/coffersfaqca).

**EasyElegance™**

PVC PLASTIC CEILINGS

# EASY ELEGANCE™ FLAT AND TEXTURED CEILING PANELS

Easy Elegance™ Flat and Textured square edge ceiling panels are made of rigid PVC plastic and are available in two sizes—24-in × 24-in and 24-in × 48-in. Panels can be used alone or as a perimeter border for Easy Elegance™ Coffered ceiling panels.\*

## FEATURES & BENEFITS

- Rigid PVC Plastic
- Flat White panels have a bright white, satin finish
- Flat Black panels have a black, matte finish
- Textured White and Textured Black panels have a low-gloss cobbled finish
- Easy to clean—washable
- Durable—impact resistant
- Mold, mildew, and sag resistance
- Stain resistant
- Will not discolor
- Lightweight—easy to cut and install in 15/16-in standard grid
- Paintable
- For residential use only

\* NOTE: Color of Flat White panels and Textured White panels may not be an exact match with White Coffered panel color.

## FLAT PANEL STYLES

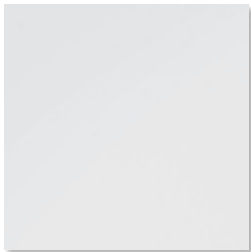

1278 EASY ELEGANCE™  
FLAT WHITE

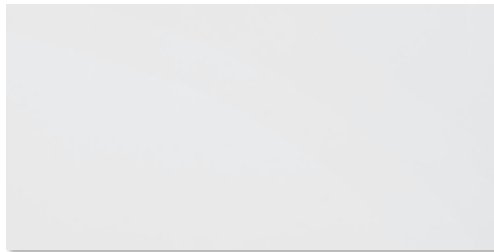

1279 EASY ELEGANCE FLAT WHITE



SHOWING  
SQUARE  
EDGE  
DETAIL

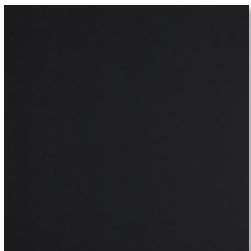

1278BL EASY ELEGANCE  
FLAT BLACK



1279BL EASY ELEGANCE FLAT BLACK



1278 EASY ELEGANCE™ FLAT WHITE (CEILING)



FLAT  
WHITE  
BORDER  
PANEL

1280BXA EASY ELEGANCE™ DEEP COFFER WHITE WITH  
1278 FLAT WHITE USED AS A PERIMETER BORDER



## TEXTURED PANEL STYLES



1283 EASY ELEGANCE™  
TEXTURED WHITE

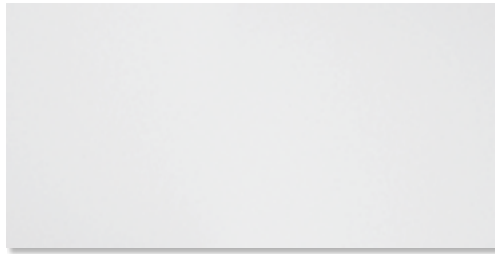

1284 EASY ELEGANCE TEXTURED WHITE

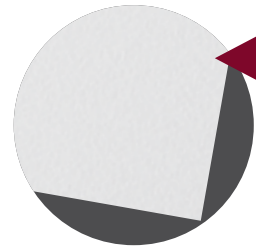

ENLARGED  
TO SHOW  
DETAIL

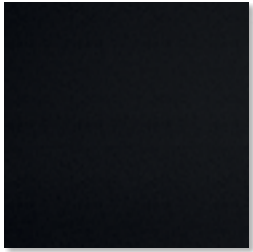

1283BL EASY ELEGANCE  
TEXTURED BLACK

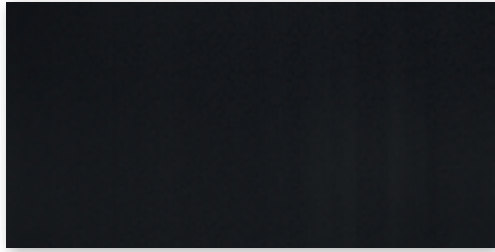

1284BL EASY ELEGANCE TEXTURED BLACK



1284 EASY ELEGANCE™ TEXTURED WHITE (CEILING)

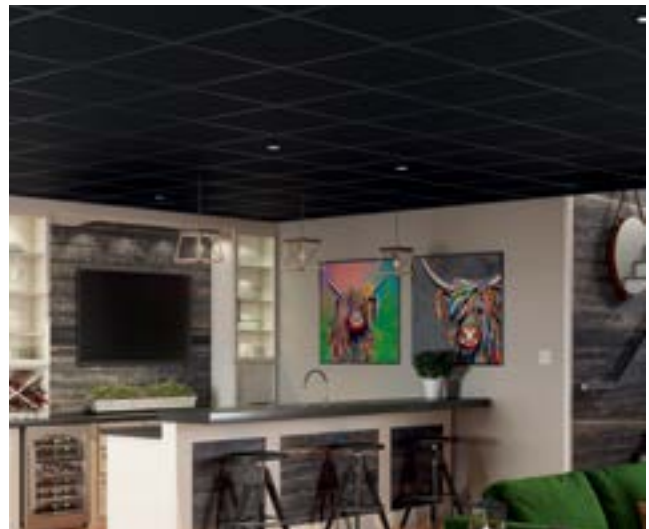

1283BL EASY ELEGANCE TEXTURED BLACK (CEILING)

PVC PLASTIC



SUSPENDED (DROP) OR

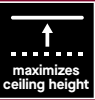

SURFACE MOUNT (DIRECT APPLY) CEILINGS

EasyElegance™

PVC PLASTIC CEILINGS

ceilings.com/canada

# PRODUCT SPECIFICATIONS

Item #	Edge Detail	Dimensions (Inches)	Install System	Noise Reducing NRC/CAC	Sag Resistance	Mold Resistance	Fog	Spray	Wipe	Light Reflectance	Fire Resistance	SF Per Ctn	Pcs/ Ctn	Material Type
<b>Coffered Ceiling Panels</b>														
1280BXA	Tegular	24 × 24 × 2 1/2	15/16-in	-/-	Superior	Superior	-	-	-	0.85	Class A	4	1**	Rigid PVC
1280BLBXA*	Tegular	24 × 24 × 2 1/2	15/16-in	-/-	Superior	Superior	-	-	-	-	Class A	4	1**	Rigid PVC
1282BXA	Tegular	24 × 24 × 7/10	15/16-in	-/-	Superior	Superior	-	-	-	0.85	Class A	4	1**	Rigid PVC
1282BLBXA*	Tegular	24 × 24 × 7/10	15/16-in	-/-	Superior	Superior	-	-	-	-	Class A	4	1**	Rigid PVC
<b>Flat Panels</b>														
1278	Square	24 × 24 × 1/5	15/16-in	-/-	Superior	Superior	-	✓	✓	0.90	Class A	40	10	Rigid PVC
1278BL	Square	24 × 24 × 1/5	15/16-in	-/-	Superior	Superior	-	✓	✓	-	Class A	40	10	Rigid PVC
1279	Square	24 × 48 × 1/5	15/16-in	-/-	Superior	Superior	-	✓	✓	0.90	Class A	64	8	Rigid PVC
1279BL	Square	24 × 48 × 1/5	15/16-in	-/-	Superior	Superior	-	✓	✓	-	Class A	64	8	Rigid PVC
<b>Textured Panels</b>														
1283	Square	24 × 24 × 1/5	15/16-in	-/-	Superior	Superior	-	✓	✓	-	Class A	40	10	Rigid PVC
1283BL	Square	24 × 24 × 1/5	15/16-in	-/-	Superior	Superior	-	✓	✓	-	Class A	40	10	Rigid PVC
1284	Square	24 × 48 × 1/5	15/16-in	-/-	Superior	Superior	-	✓	✓	-	Class A	64	8	Rigid PVC
1284BL	Square	24 × 48 × 1/5	15/16-in	-/-	Superior	Superior	-	✓	✓	-	Class A	64	8	Rigid PVC

\*Coordinating 64 sq. ft. black grid kits (6362BL) are available  
 \*\*Coffer items are sold by the piece; minimum order quantity of 4

## INSTALLATION SYSTEM

- Tegular edge products minimize grid look
- Square edge products have a visible grid
- Prelude® 15/16-in suspension system

See pages 40-48 for additional information.

For installation instructions, please visit [ceilings.com/installationca](http://ceilings.com/installationca).

**NOTE:** Discover how to enhance your suspended ceiling installation with StyleStix™ PVC suspended ceiling grid moldings; visit [ceilings.com/stylestixca](http://ceilings.com/stylestixca).



1310BX, 1311BX, 1312BX STYLESTIX™ WITH 273 SAHARA™ PANELS (CEILING)



# EASY ELEGANCE™ PLANK WOODGRAIN WHITE

Maintenance-free, durable Easy Elegance™ Plank Woodgrain White ceilings are the optimal solution for spaces where both a plank ceiling is desired and where moisture and humidity are a concern. The 6-in × 48-in beveled tongue and groove planks install in 2 ways on ceilings and can also be installed to walls.



1293 EASY ELEGANCE™ PLANK WOODGRAIN WHITE



SHOWING EDGE DETAIL

## FEATURES & BENEFITS

- Rigid, durable PVC Plastic
- Woodgrain appearance
- Easy to clean—washable
- Mold, mildew and sag resistance
- Stain resistant
- Will not discolor
- Lightweight—easy to cut and install
- For residential use only
- For interior, climate-controlled spaces only

## PRODUCT SPECIFICATIONS

Item #	Edge Detail	Dimensions (Inches)	Install System	Noise Reducing NRC/CAC	Sag Resistance	Mold Resistance	Fog	Spray	Wipe	Light Reflectance	Fire Resistance	SF Per Ctn	Pcs/ Ctn	Material Type
1293	Beveled Tongue & Groove	6 × 48 × 1/3	Direct Apply	-/-	Superior	Superior	-	✓	✓	0.90	Class A	20	10	Rigid PVC

## CEILING & WALL INSTALLATION



- Installs directly to an existing ceiling with Easy Up® tracks and clips or adhesive (See pages 51 and 52 for additional information)
- Install to walls vertically or horizontally with adhesive

For installation instructions, please visit [ceilings.com/installationca](http://ceilings.com/installationca).



1293 EASY ELEGANCE™ PLANK WOODGRAIN WHITE (CEILING)

**EasyElegance™**  
PVC PLASTIC CEILING



1205 SINGLE RAISED PANEL (CEILING)

**Decorative**Look

# 24-in × 24-in DECORATIVE CEILINGS



1201 RAISED PANEL™



1202 SCALLOPED



ENLARGED  
TO SHOW  
DETAIL



1203 FLUTED



1205 SINGLE RAISED PANEL  
1210 SINGLE RAISED PANEL



1206 TANGO



1270 CASCADE\*



8008 TINCRAFT™ CIRCLES















































8009 TINCRAFT™ SQUARES



## FEATURES & BENEFITS

- Variety of decorative styles to enhance any décor
- Grid-blending design masks the industrial look of metal grid
- For a narrow grid look, 8009 and 1210 install on 9/16-in Suprafine® grid
- Easy installation system provides access to pipes, ducts and wiring

## PRODUCT SPECIFICATIONS

Item #	Edge Detail	Dimensions (Inches)	Install System	Noise Reducing NRC/CAC	Sag Resistance	Mold Resistance	Light Reflectance	Fire Resistance	SF Per Ctn	Pcs/Ctn	Material Type
1201	 Tegular	24 × 24 × 5/8	15/16-in	 -/30	 Standard	 Standard	0.78	 Class A	24	6	Mineral Fiber
1202	 Tegular	24 × 24 × 5/8	15/16-in	 -/30	 Standard	 Standard	0.78	 Class A	24	6	Mineral Fiber
1203	 Tegular	24 × 24 × 5/8	15/16-in	 -/30	 Standard	 Standard	0.78	 Class A	24	6	Mineral Fiber
1205	 Tegular	24 × 24 × 5/8	15/16-in	 -/30	 Standard	 Standard	0.78	 Class A	24	6	Mineral Fiber
1206	 Tegular	24 × 24 × 5/8	15/16-in	 -/30	 Standard	 Standard	0.78	 Class A	24	6	Mineral Fiber
1210	 Tegular	24 × 24 × 3/4	9/16-in	 -/30	 Standard	 Standard	0.78	 Class A	24	6	Mineral Fiber
1270	 Tegular	24 × 24 × 3/4	15/16-in	 -/30	 Standard	 Standard	0.80	 Class A	48	12	Mineral Fiber
8008	 Tegular	24 × 24 × 3/4	15/16-in	 -/35	 Standard	 Standard	0.78	 Class A	48	12	Mineral Fiber
8009	 Tegular	24 × 24 × 3/4	9/16-in	 -/35	 Standard	 Standard	0.78	 Class A	32	8	Mineral Fiber

## INSTALLATION SYSTEM

- Tegular edge products minimize grid look
- Prelude® 15/16-in suspension system
- Suprafine® 9/16-in suspension system (1210 and 8009 only)

See pages 40-48 for additional information.

For installation instructions, please visit [ceilings.com/installationca](http://ceilings.com/installationca).



1270 CASCADE® (CEILING)

# DecorativeLook



SMOOTH LOOK



SUSPENDED (DROP) CEILING

271 SAHARA™ (CEILING)—Similar look can be achieved with 24-in × 48-in 9768 SAHARA™ SCORED II

SmoothLook

## 24-in × 24-in SMOOTH LOOK CEILINGS



269 SAND PEBBLE™

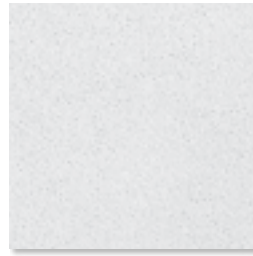
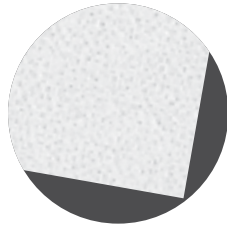

271 SAHARA™  
273 SAHARA  
276 SAHARA

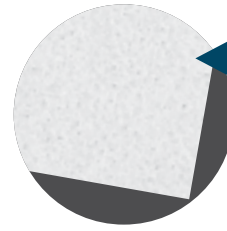

ENLARGED  
TO SHOW  
DETAIL



292 ZEPHYR®

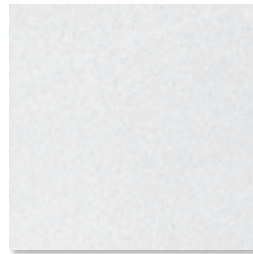
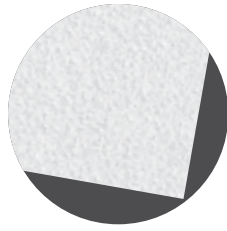

490 YUMA WHITE®  
492 YUMA WHITE

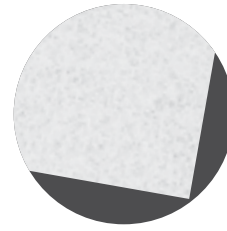

973 LUMAWASH®

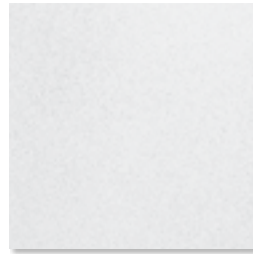
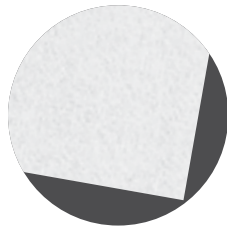

1231 BRIGHTEX™ WITH  
AIRGUARD™

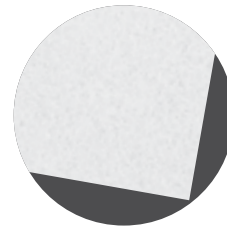

# SmoothLook





## FEATURES & BENEFITS

- Ideal for basements, home theaters and light commercial spaces
- Mold, mildew, and sag resistance
- Acoustical; most absorb >50% of noise (except 973)
- Easy installation system provides access to pipes, ducts and wiring
- For a narrow grid look, 276 and 1231 install on 9/16-in Suprafine® grid
- 973 meets USDA guidelines for use in food processing areas



269 SAND PEBBLE™ (CEILING)

# SmoothLook

## 24-in × 48-in SMOOTH LOOK CEILINGS

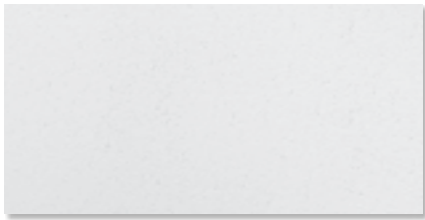

280 PLAIN WHITE

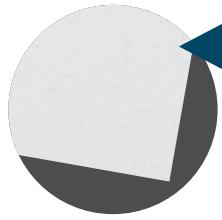

ENLARGED  
TO SHOW  
DETAIL

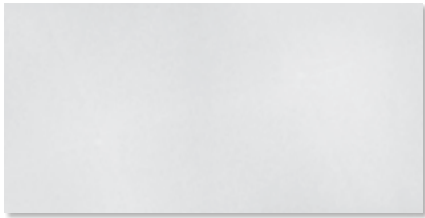

491 YUMA WHITE®  
493 YUMA WHITE

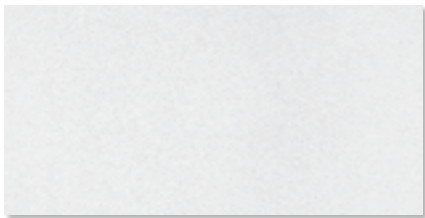
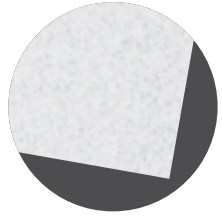

972 LUMAWASH®

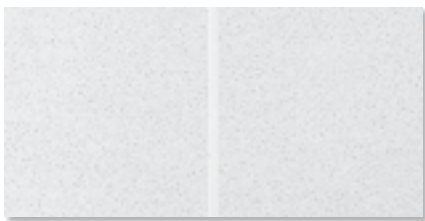
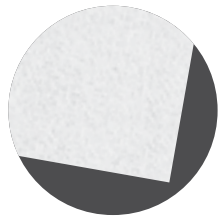

9768 SAHARA™ SCORED II

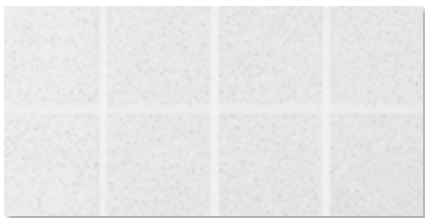
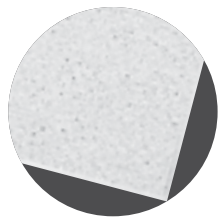

9769 SAHARA™ SCORED I

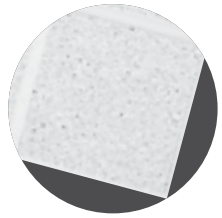

# SmoothLook



## FEATURES & BENEFITS















- Great for new, replacement and matching ceilings
- Mold, mildew, and sag resistance
- Acoustical; most absorb >50% of noise (except 280 and 972)
- Easy installation system provides access to pipes, ducts and wiring
- 972 meets USDA guidelines for use in food processing areas
- 9768 and 9769 are scored to give a 2-ft × 2-ft or a 1-ft × 1-ft visual on a 2-ft × 4-ft panel



9769 SAHARA™ SCORED I (CEILING)

SmoothLook

## PRODUCT SPECIFICATIONS

Item #	Edge Detail	Dimensions (Inches)	Install System	Noise Reducing	Sag Resistance	Mold Resistance	Fog	Spray	Wipe	Light Reflectance	Fire Resistance	SF Per Ctn	Pcs/Ctn	Material Type
				NRC/CAC										
269	 Tegular	24 × 24 × 5/8	15/16-in	0.55/30	Superior	Superior	-	-	-	0.80	Class A	64	16	Mineral Fiber
271	 Tegular	24 × 24 × 5/8	15/16-in	0.50/35	Superior	Superior	-	-	-	0.81	Class A	64	16	Mineral Fiber
273	 Square	24 × 24 × 5/8	15/16-in	0.50/35	Superior	Superior	-	-	-	0.81	Class A	64	16	Mineral Fiber
276	 Tegular	24 × 24 × 5/8	9/16-in	0.50/35	Superior	Superior	-	-	-	0.81	Class A	64	16	Mineral Fiber
280	 Square	24 × 48 × 1/2	15/16-in	-/30	Standard	Standard	-	-	-	0.80	Class A	64	8	Mineral Fiber
292	 Square	24 × 24 × 5/8	15/16-in	-/33	Superior	Superior	-	-	-	0.87	Class A	64	16	Mineral Fiber
490	 Square	24 × 24 × 5/8	15/16-in	0.55/35	Superior	Superior	-	-	-	0.80	Class A	64	16	Mineral Fiber
491	 Square	24 × 48 × 5/8	15/16-in	0.55/35	Superior	Superior	-	-	-	0.80	Class A	64	8	Mineral Fiber
492	 Tegular	24 × 24 × 5/8	15/16-in	0.55/35	Superior	Superior	-	-	-	0.80	Class A	64	16	Mineral Fiber
493	 Tegular	24 × 48 × 5/8	15/16-in	0.55/35	Superior	Superior	-	-	-	0.80	Class A	64	8	Mineral Fiber
972	 Square	24 × 48 × 5/8	15/16-in	-/33	Superior	Superior	✓	✓	✓	0.89	Class A	64	8	Mineral Fiber
973	 Square	24 × 24 × 5/8	15/16-in	-/33	Superior	Superior	✓	✓	✓	0.89	Class A	64	16	Mineral Fiber
1231	 Tegular	24 × 24 × 3/4	9/16-in	0.65/35	Superior	Superior	-	-	-	0.88	Class A	32	8	Mineral Fiber
9768	 Tegular	24 × 48 × 3/4	15/16-in	0.50/35	Superior	Superior	-	-	-	0.81	Class A	64	8	Mineral Fiber
9769	 Tegular	24 × 48 × 3/4	15/16-in	0.50/35	Superior	Superior	-	-	-	0.81	Class A	64	8	Mineral Fiber

## INSTALLATION SYSTEM

- Tegular edge products minimize grid look
- Square edge products have a visible grid
- Prelude® 15/16-in suspension system
- Suprafine® 9/16-in suspension system (276 and 1231 only)

See pages 40-48 for additional information.

For installation instructions, please visit [ceilings.com/installationca](http://ceilings.com/installationca).

# SmoothLook



TEXTURED LOOK



SUSPENDED (DROP) CEILING

954 CLASSIC FINE TEXTURED (CEILING)

**TexturedLook**

# 24-in × 24-in TEXTURED LOOK CEILINGS



241 SUPERTUFF™

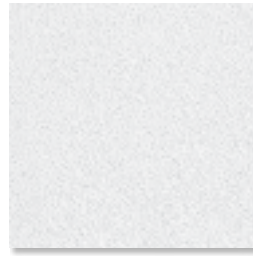
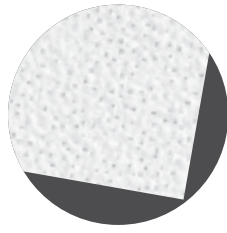

266 BRIGHTON™

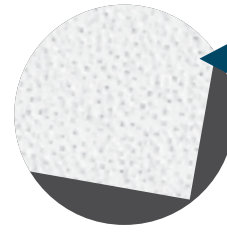

ENLARGED  
TO SHOW  
DETAIL

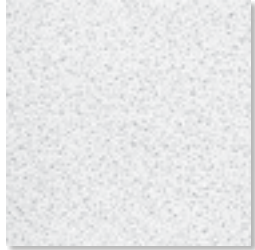

928 FINE FISSURED™  
932 FINE FISSURED

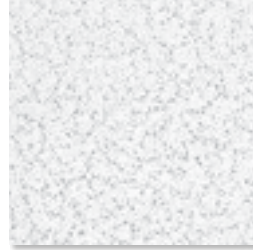
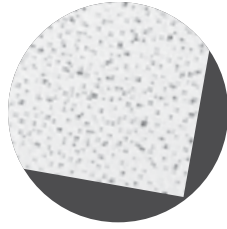

934 RANDOM TEXTURED  
935 RANDOM TEXTURED

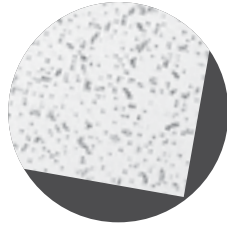

949 TEXTURED

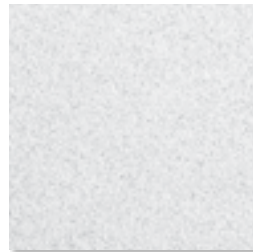
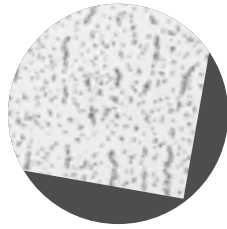

954 CLASSIC FINE TEXTURED

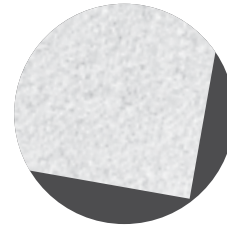

1728BL FINE FISSURED™ BLACK

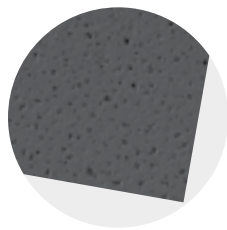

**TexturedLook**



## FEATURES & BENEFITS

- Ideal for basements and home theaters
- Acoustical; most absorb >50% of noise (except 266)
- Easy installation system provides access to pipes, ducts and wiring
- 241, 928, 932, 954 and 1728BL offer economical high performance (sag, mold, and mildew resistance) and a range of visuals



1728BL FINE FISSURED™ BLACK™ (CEILING)

*NOTE: Coordinating 64 sq. ft. black grid kits (6362BL) are available.*

# TexturedLook

## 24-in × 48-in TEXTURED LOOK CEILINGS

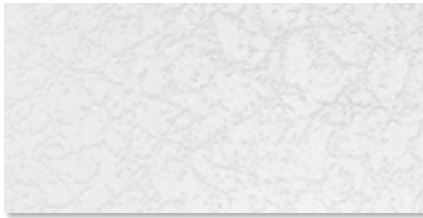

297 GRENOBLE™

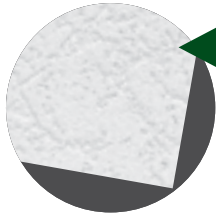

ENLARGED  
TO SHOW  
DETAIL

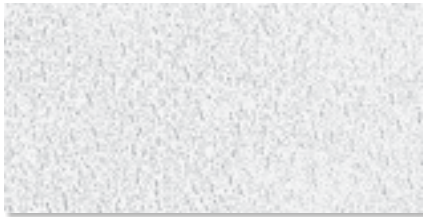

902 TEXTURED

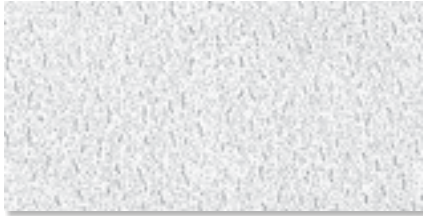
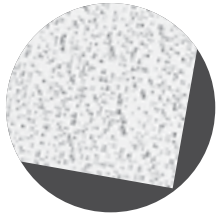

915 Textured FIRE GUARD™

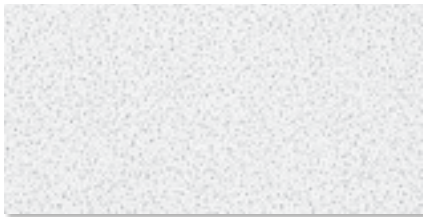
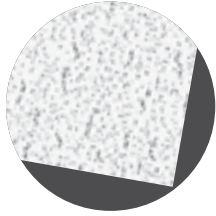

922 FINE FISSURED™

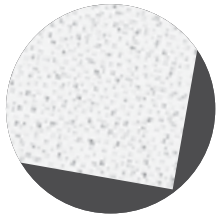

933 RANDOM TEXTURED

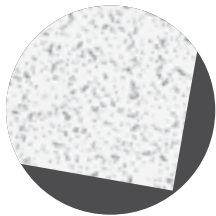

### FEATURES & BENEFITS

- Great for new, replacement and matching ceilings
- Many are acoustical; reduce noise 55%
- Non-directional image reduces labor and scrap (922, 933 and 9767)
- Easy installation system provides access to pipes, ducts and wiring
- 915 must be installed in a Fire Guard™ grid to achieve fire resistant UL ratings
- 922 offers economical high performance (sag, mold and mildew resistance) and a more subtle textured visual

**Textured**Look





# 24-in x 48-in TEXTURED LOOK CEILINGS (continued)



942 TEXTURED

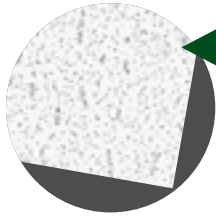

ENLARGED TO SHOW DETAIL

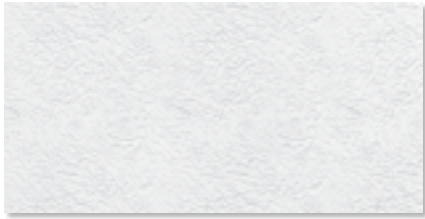

1133 BALTIC™

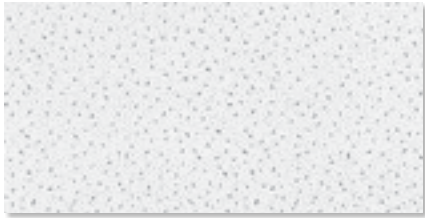
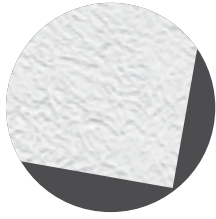

1301 NON-DIRECTIONAL

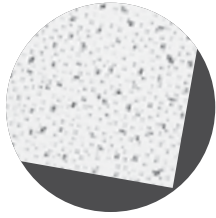



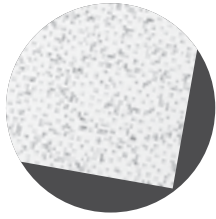















9767 SCORED



922 FINE FISSURED™ (CEILING)

# TexturedLook

## PRODUCT SPECIFICATIONS

Item #	Edge Detail	Dimensions (Inches)	Install System	Noise Reducing	Sag	Mold	Fog	Spray	Wipe	Light Reflectance	Fire	SF Per Ctn	Pcs/Ctn	Material Type
				NRC/CAC	Resistance	Resistance					Resistance			
241	 Tegular	24 × 24 × 5/8	15/16-in	0.50/33	Superior	Superior	-	-	-	0.86	Class A	48	12	Mineral Fiber
266	 Tegular	24 × 24 × 1/2	15/16-in	0.45/30	Standard	Superior	-	-	-	0.86	Class A	64	16	Mineral Fiber
297	 Square	24 × 48 × 1/2	15/16-in	-/30	Standard	Standard	-	-	-	0.80	Class A	64	8	Mineral Fiber
902	 Square	24 × 48 × 1/2	15/16-in	-/30	Standard	Standard	-	-	-	0.80	Class A	64	8	Mineral Fiber
915	 Square	24 × 48 × 5/8	15/16-in	0.55/35	Standard	Standard	-	-	-	0.79	Class A	64	8	Mineral Fiber
922	 Square	24 × 48 × 5/8	15/16-in	0.55/35	Superior	Superior	✓	-	-	0.82	Class A	64	8	Mineral Fiber
928	 Square	24 × 24 × 5/8	15/16-in	0.55/33	Superior	Superior	✓	-	-	0.82	Class A	64	16	Mineral Fiber
932	 Tegular	24 × 24 × 5/8	15/16-in	0.55/35	Superior	Superior	✓	-	-	0.82	Class A	64	16	Mineral Fiber
933	 Square	24 × 48 × 5/8	15/16-in	0.55/35	Standard	Standard	-	-	-	0.80	Class A	80	10	Mineral Fiber
934	 Tegular	24 × 24 × 5/8	15/16-in	0.55/33	Standard	Standard	-	-	-	0.80	Class A	64	16	Mineral Fiber
935	 Square	24 × 24 × 5/8	15/16-in	0.55/33	Standard	Standard	-	-	-	0.80	Class A	64	16	Mineral Fiber
942	 Square	24 × 48 × 5/8	15/16-in	0.55/30	Standard	Standard	-	-	-	0.79	Class A	80	10	Mineral Fiber
949	 Square	24 × 24 × 5/8	15/16-in	0.55/33	Standard	Standard	-	-	-	0.79	Class A	64	16	Mineral Fiber
954	 Tegular	24 × 24 × 3/4	15/16-in	0.70/35	Superior	Superior	-	-	-	0.85	Class A	48	12	Mineral Fiber
1133	 Square	24 × 24 × 1/2	15/16-in	-/30	Standard	Standard	-	-	-	0.80	Class A	64	8	Mineral Fiber
1301	 Square	24 × 48 × 1/2	15/16-in	0.45/30	Standard	Standard	-	-	-	0.80	Class A	96	12	Mineral Fiber
1728BL*	 Square	24 × 24 × 5/8	15/16-in	0.55/33	Superior	Superior	-	-	-	0.06	Class A	64	16	Mineral Fiber
9767	 Tegular	24 × 48 × 3/4	15/16-in	0.55/35	Standard	Standard	-	-	-	0.82	Class A	80	10	Mineral Fiber

\*Coordinating 64 sq. ft. black grid kits (6362BL) are available.

## INSTALLATION SYSTEM

- Tegular edge products minimize grid look
- Square edge products have a visible grid
- Prelude® 15/16-in suspension system

See pages 40-48 for additional information.

For installation instructions, please visit [ceilings.com/installationca](http://ceilings.com/installationca).

## TexturedLook



## 24-in × 48-in FIBERGLASS CEILINGS

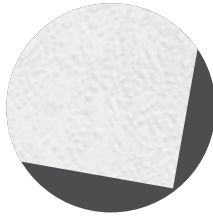
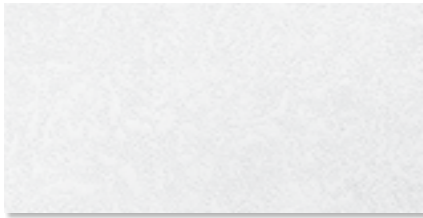

403 ESPRIT® FIBERGLASS

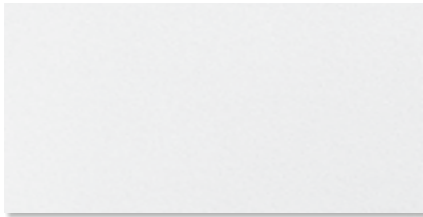

404 PEBBLE™ FIBERGLASS

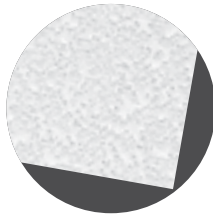
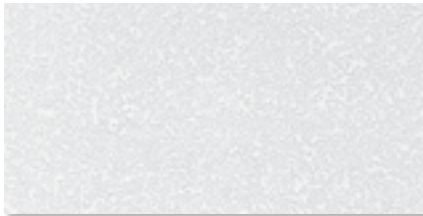

410 SONOFLEX™ RANDOM FISSURED™ FIBERGLASS

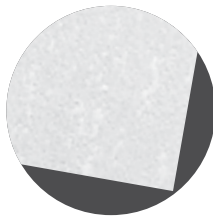
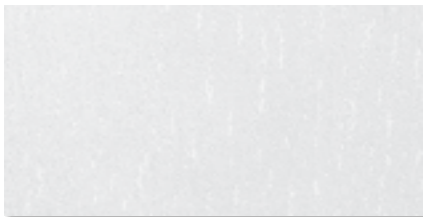









416 SONOFLEX™ ETCHED FIBERGLASS

### FEATURES & BENEFITS

- Great for new, replacement and matching commercial applications
- Easy installation system provides access to pipes, ducts and wiring
- Acoustical; reduce noise >50%
- Sag, mold, and mildew resistance
- Offers a lightweight, easy to handle alternative to traditional mineral fiber ceiling options

**TexturedLook**

## PRODUCT SPECIFICATIONS

Item #	Edge Detail	Dimensions (Inches)	Install System	Noise Reducing NRC/CAC 	Sag Resistance 	Mold Resistance 	Light Reflectance	Fire Resistance 	SF Per Ctn	Pcs/Ctn	Material Type
403	 Square	24 × 48 × 5/8	15/16-in	0.55/-	Superior	Superior	0.72	Class A	128	16	Fiberglass
404	 Square	24 × 48 × 5/8	15/16-in	0.50/-	Superior	Superior	0.85	Class A	128	16	Fiberglass
410	 Square	24 × 48 × 5/8	15/16-in	0.55/-	Superior	Superior	0.72	Class A	128	16	Fiberglass
416	 Square	24 × 48 × 5/8	15/16-in	0.55/-	Superior	Superior	0.72	Class A	128	16	Fiberglass

## INSTALLATION SYSTEM



- Square edge products have a visible grid
- Prelude® 15/16-in suspension system

See pages 40-48 for additional information.

For installation instructions, please visit [ceilings.com/installationca](http://ceilings.com/installationca).



403 ESPRIT® FIBERGLASS (CEILING)

# TexturedLook



12-in x 12-in



SURFACE MOUNT (DIRECT APPLY) CEILINGS

46 WELLINGTON™ (CEILING)

**TinLook™**  
PAINTABLE CEILINGS

# 12-in × 12-in TINLOOK™ CEILINGS



46 WELLINGTON™



1240 TINTILE™



ENLARGED TO SHOW DETAIL



1244 CIRCLES



## FEATURES & BENEFITS

- Made of mineral fiber (similar material to standard ceiling products)
- Vintage tin ceiling look at an affordable price
- Paintable to match any décor
- Great for covering damaged drywall, plaster or popcorn ceilings

## PRODUCT SPECIFICATIONS

Item #	Edge Detail	Dimensions (Inches)	Install System	Noise Reducing NRC/CAC	Sag Resistance	Mold Resistance	Light Reflectance	Fire Resistance	SF Per Ctn	Pcs/Ctn	Material Type
46	Square Tongue & Groove	12 × 12 × 1/2	Easy Up	-/30	Standard	Standard	0.76	Class A	40	40	Mineral Fiber
1240	Square Tongue & Groove	12 × 12 × 1/2	Easy Up	-/30	Standard	Standard	0.80	Class A	40	40	Mineral Fiber
1244	Square Tongue & Groove	12 × 12 × 1/2	Easy Up	-/30	Standard	Standard	0.80	Class A	40	40	Mineral Fiber

## INSTALLATION SYSTEM

- Tongue & groove products have no visible grid
- Easy Up® installation system or adhesive

See pages 51 and 52 for additional information.

For installation instructions, please visit [ceilings.com/installationca](http://ceilings.com/installationca).

Painting will void warranty.



## 12-in x 12-in CEILINGS



231 WASHABLE WHITE\*

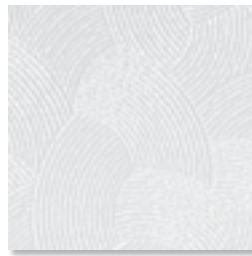

250 PINEHURST™

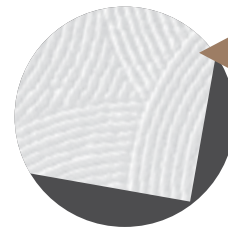

ENLARGED TO SHOW DETAIL



257 SAND PEBBLE™

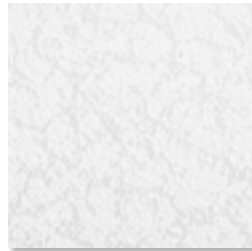
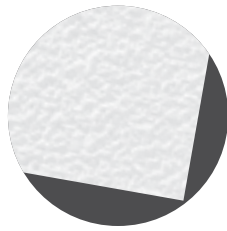

258 GRENOBLE™

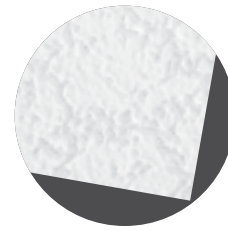

1132 BALTIC™

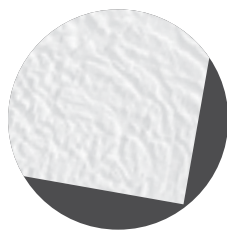

### FEATURES & BENEFITS

- Paintable to match any décor
- Great for covering damaged drywall, plaster or popcorn ceilings

### PRODUCT SPECIFICATIONS

Item #	Edge Detail	Dimensions (Inches)	Install System	Noise Reducing NRC/CAC	Sag Resistance	Mold Resistance	Light Reflectance	Fire Resistance	SF Per Ctn	Pcs/Ctn	Material Type
231	Beveled Tongue & Groove	12 x 12 x 1/2	Easy Up	-/30	Standard	Standard	0.80	Class A	40	40	Mineral Fiber
250	Beveled Tongue & Groove	12 x 12 x 1/2	Easy Up	-/30	Standard	Standard	0.80	Class A	40	40	Mineral Fiber
257	Beveled Tongue & Groove	12 x 12 x 1/2	Easy Up	-/30	Standard	Standard	0.80	Class A	40	40	Mineral Fiber
258	Beveled Tongue & Groove	12 x 12 x 1/2	Easy Up	-/30	Standard	Standard	0.80	Class A	40	40	Mineral Fiber
1132	Beveled Tongue & Groove	12 x 12 x 1/2	Easy Up	-/30	Standard	Standard	0.80	Class A	40	40	Mineral Fiber

### INSTALLATION SYSTEM



- Tongue & groove products have no visible grid
- Easy Up® installation system or adhesive

See pages 51 and 52 for additional information.

For installation instructions, please visit [ceilings.com/installationca](http://ceilings.com/installationca).

Painting will void warranty.

\*This tile may be cleaned by lightly wiping with a soft, damp cloth, or by using a vacuum hose with a soft brush attachment. Do not scrub, immerse, or soak tiles in water or use soap.

## 12-in x 12-in Ceilings



2012WH ACOUSTAFFIX® WHITE (CEILING)

**AcoustAffix®**  
SURFACE MOUNT CEILING  
& WALL PANELS





# ACOUSTAFFIX® SURFACE MOUNT CEILING AND WALL PANELS

Control acoustics while maintaining an open, exposed structure design with AcoustAffix® fine-textured panels.

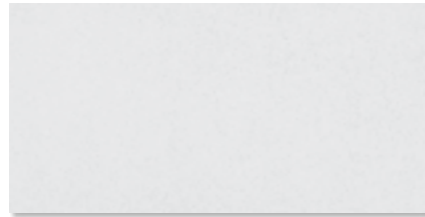

2012WH ACOUSTAFFIX® WHITE

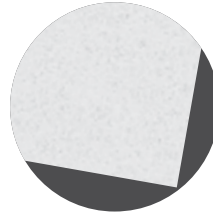

2012BL ACOUSTAFFIX® BLACK

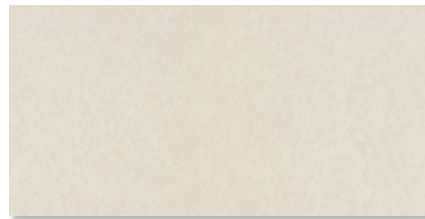
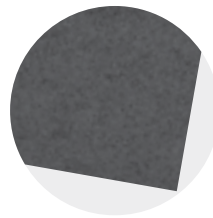

2012 ACOUSTAFFIX® FIELD PAINTABLE

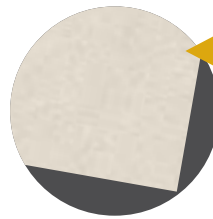

ENLARGED TO SHOW DETAIL

## FEATURES & BENEFITS

- Panels install using adhesive, Armstrong All-in-one Self-stop Fastener, or Armstrong Truss Mounting Kit
- Ideal for exposed structure ceilings and walls when traditional suspended ceilings are not desired
- Designed to blend in with the existing deck while providing superior sound absorption (NRC 0.75)
- Mounts directly to structure, screwed into hat track or drywall grid
- Three options available—field paintable, and prefinished black and white
- Prefinished options have a smooth, clean durable finish—scratch-resistant, soil-resistant

## PRODUCT SPECIFICATIONS

Item #	Edge Detail	Dimensions (Inches)	Install System	Noise Reducing	Sag Resistance	Mold Resistance	Fog	Spray	Wipe	Light Reflectance	Fire Resistance	SF Per Ctn	Pcs/ Ctn	Material Type
				NRC/CAC	Resistance	Resistance	Icon	Icon	Icon	Icon				
2012	Square	24 × 48 × 3/4	Various	0.75/-	Superior	Superior	✓	-	-	-	Class A	48	6	Mineral Fiber
2012WH 2012BL	Square/ Reverse Tegular	24 × 48 × 3/4	Various	0.75/-	Superior	Superior	✓	-	-	-	Class A	48	6	Mineral Fiber



2012BL ACOUSTAFFIX® BLACK (CEILING)

**AcoustAffix®**  
SURFACE MOUNT CEILING  
& WALL PANELS

# ACOUSTAFFIX® PANEL INSTALLATION OPTIONS

## 1 ALL-IN-ONE SELF-STOP FASTENER IN COORDINATING FINISHES



All-in-one Self-stop Fastener eliminates the need for a separate washer, allowing for a fast installation. A built-in self-stop feature prevents over-driving and damaging the panel. Fastener can be used for both ceiling and wall installations and are available in coordinating finishes: White (2021WH), Black (2021BL), Mill (2021).

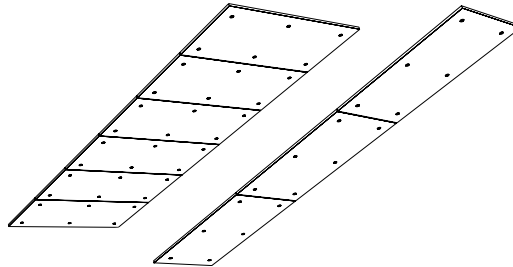

**Horizontal Installation:** Panels installed with Self-stop Fastener on steel furring channel or drywall grid.

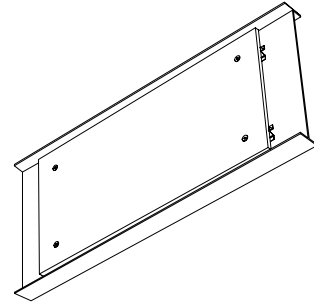

**Vertical Installation:** Panels installed with Self-stop Fastener on steel furring channel on an I-Beam.

## 2 TRUSS MOUNTING KIT IN COORDINATING FINISHES



The Truss Mounting Kit includes threaded rods and weld nuts and allows for panel installation on an open truss system. Field modifiable rods will work with a wide range of truss layouts and thicknesses. Available in coordinating finishes: White (2022WH), Black (2022BL), Mill (2022).

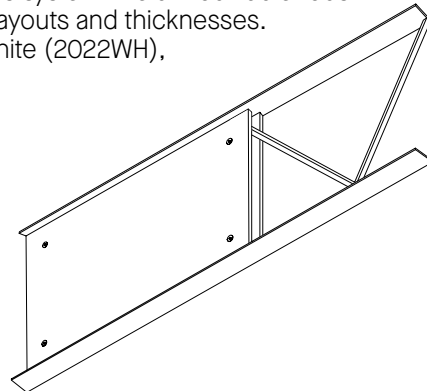

**Vertical Installation:** Panels (in pairs) installed with Mounting Kit on truss.

## 3 ADHESIVE



Panels can be adhered to concrete, drywall and plaster with Titebond® GREENchoice Acoustical Ceiling Tile Adhesive. Follow adhesive manufacturer's instructions for application and usage.

Titebond and GREENchoice are trademarks of Franklin International.



For videos and full installation instructions (including wall installation) visit [ceilings.com/acoustaffixca](https://ceilings.com/acoustaffixca).



# SUSPENDED (DROP) CEILING INSTALLATION

- Need access above your ceiling?
- Have 3-in of headroom to spare?

## WHY USE AN ARMSTRONG® SUSPENDED (DROP) CEILING VS DRYWALL?

- Accessibility to pipes, duct work and wiring
- Faster and cleaner installation
- May reduce noise and resist mold/mildew
- Broad selection of visuals
- Easy to repair and replace damaged or stained panels

## INSTALLATION



1 Install wall molding



2 Suspend main beams with hanging hardware



3 Install cross tees



4 Install ceiling panels

## PRELUDE® (15/16-in FACE) AND SUPRAFINE® (9/16-in FACE) CEILING SUSPENSION SYSTEMS

- Heavy-duty performance (7301); intermediate-duty performance (Prelude 7300, Suprafine 7500)
- Meets all building codes for residential and non-residential construction
- Easy installation—Choice of stab-in (XL) or hook-in (ML) cross tees; only 3-in clearance required (Prelude only)
- Rotary stitched during manufacture for additional torsional strength and extra stability during installation
- SuperLock™ main beam clip is engineered for a strong, secure connection and fast, accurate alignment confirmed with audible click; easy to remove/relocate
- Hot-dipped galvanized coating inhibits red rusting better than electrogalvanized or painted systems
- 10-year limited warranty; 30-year with Armstrong® high-performance ceiling panels

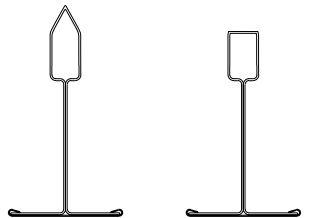

PeakForm®

Square Bulb



15/16-in grid



9/16-in grid

PeakForm® profile increases strength and stability for improved performance during installation.

PeakForm products (cross tees and main beams) offer a superior load-carrying capacity than typical square bulb.



Fire Guard™ product options for UL design fire-rated performance only.

Expansion Relief on Fire Guard™ Main Beam.

# QUICKHANG™ GRID HOOK AND INSTALLATION KITS



## QUICKHANG GRID HOOK KITS

QuickHang™ hooks and brackets offer a new way to install a basement drop ceiling system directly to joists more quickly and easily than with hanger wire. The QuickHang system is available in two new accessory kits with different length hooks.



## PRODUCT SPECIFICATIONS

Item #	Product Name	Length (Inches)	Kits/Ctn	Components/ Individual Kits	SF Per Ctn*
6366	QuickHang 6-in Grid Hook Kits – Master Carton	6-in Hook	Includes 12 Kits	6 Hooks 6 Brackets 20 Nails	(160 per individual kit)
6367	QuickHang 6-in Grid Hook Kit – Individual Kit	6-in Hook	N/A	6 Hooks 6 Brackets 20 Nails	(160 per individual kit)
6368	QuickHang 12-in Grid Hook Kits – Master Carton	12-in Hook	Includes 12 Kits	6 Hooks 6 Brackets 20 Nails	(160 per individual kit)
6369	QuickHang 12-in Grid Hook Kit – Individual Kit	12-in Hook	N/A	6 Hooks 6 Brackets 20 Nails	(160 per individual kit)

\*Based on a 10-ft × 16-ft room; for residential use only

## BENEFITS

- Use with standard grid
- Attach drop ceiling grid to joists
- Save time – faster than hanger wire
- Easily level a grid system
- Minimize drop (less than 3-in); maximize headroom
- Avoid obstructions by using kits with 12-in hooks

## INSTALLATION STEPS:

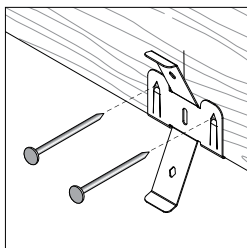

**1** Attach bracket to joist using hammer tabs & nails

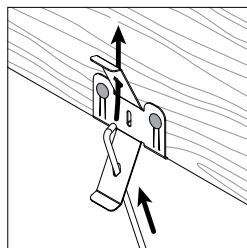

**2** Insert hook into bracket

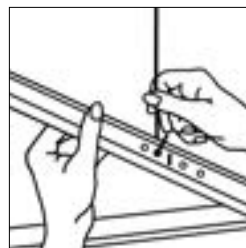

**3** Hang grid main beam on hook

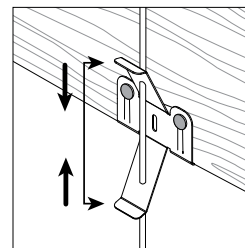

**4** Level grid by squeezing tabs & moving hook up or down

▶ For full instructions, estimating guide and videos, please visit [ceilings.com/quickhangca](http://ceilings.com/quickhangca) and [ceilings.com/videosca](http://ceilings.com/videosca).

## QUICKHANG™ INSTALLATION KITS (formerly Prelude® Installation Kits)



The new QuickHang™ installation kits have everything you need to install 64 sq. ft. of a 2-ft × 2-ft or 2-ft × 4-ft drop ceiling. These kits include the new QuickHang hooks and brackets and replace existing grid kits.

- **6362WH**—2-ft × 2-ft QuickHang Installation Kit (White)
- **6362BL**—2-ft × 2-ft QuickHang Installation Kit (Black)
- **6364WH**—2-ft × 4-ft QuickHang Installation Kit (White)

### BENEFITS

- Convenient all-in-one kits
- Perfect for dealers with consumer traffic
- Easier installs for contractors and homeowners



### INSTALL YOUR GRID SYSTEM IN 4 EASY STEPS

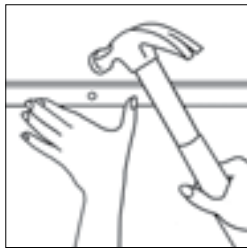

**1** Install wall molding

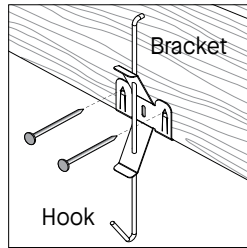

**2** Attach QuickHang™ bracket to joist and insert hook

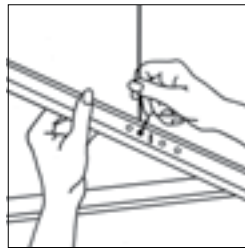

**3** Hang main beams on hooks

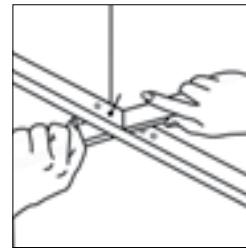

**4** Install cross tees and level by adjusting hooks

<b>2-ft × 2-ft White</b>		<b>2-ft × 2-ft Black</b>		<b>2-ft × 4-ft White</b>	
Kit Includes: 3 – 72-in Prelude® Main Beams 9 – 48-in Cross Tees 9 – 24-in Cross Tees 6 – 72-in Wall Moldings 6 – 12-in QuickHang™ Hooks 6 – Joist Brackets 40 – Nails		Kit Includes: 3 – 72-in Prelude® Main Beams 9 – 48-in Cross Tees 9 – 24-in Cross Tees 6 – 72-in Wall Moldings 6 – 12-in QuickHang™ Hooks 6 – Joist Brackets 40 – Nails		Kit Includes: 3 – 72-in Prelude® Main Beams 9 – 48-in Cross Tees 6 – 72-in Wall Moldings 6 – 12-in QuickHang™ Hooks 6 – Joist Brackets 40 – Nails	
Panel Size	24-in × 24-in		24-in × 24-in		24-in × 48-in
Kit Number	6362WH		6362BL		6364WH
Approx. Wt./Ctn. (lbs.)	15		15		13
Ctns. per Pallet	48		48		48

Please visit [ceilings.com/projectestimatorca](http://ceilings.com/projectestimatorca) to access our online material estimator for ceiling panels.

For a QuickHang installation kit estimating guide, please visit [ceilings.com/quickhangguideca](http://ceilings.com/quickhangguideca).



# SUSPENDED (DROP) CEILING INSTALLATION SYSTEMS



Suspension systems for your ceiling project have different requirements depending on the space and its intended usage. If you are unsure of your requirements, check with your local building code official. Based on your needs, simply select your color (white or black); tile size (only 2-ft x 2-ft layout requires 2-ft cross tee); and end detail (XL®—staked on clip for secure locked connection with overlap for stability or ML—hook-on end detail, butt-edge detail, easier to remove).

## Intermediate Duty — Prelude® 15/16-in Grid System

Cross Section Illustration	Prelude Item #	Product Name	Color	LBS/LF on 4 span	Length	Web Height	Flange Width	PC/CTN	LF/CTN
	7300WH	12-ft Intermediate Duty Main Beam	White	12.8	144-in	1 11/16-in	15/16-in	20	240
	7300BL	12-ft Intermediate Duty Main Beam	Black	12.8	144-in	1 11/16-in	15/16-in	20	240
	XL7342BL	4-ft Stab Cross Tee	Black		48-in	1 1/2-in	15/16-in	60	240
	XL7348RWH	4-ft Stab Cross Tee	White		48-in	1 3/8-in	15/16-in	60	240
	XL7328RWH	2-ft Stab Cross Tee	White		24-in	1 3/8-in	15/16-in	60	120
	XL7328BL	2-ft Stab Cross Tee	Black		24-in	1 3/8-in	15/16-in	60	120
	ML7343WH	4-ft Hook Cross Tee	White		48-in	1 1/2-in	15/16-in	60	240
	ML7343BL	4-ft Hook Cross Tee	Black		48-in	1 1/2-in	15/16-in	60	240
	ML7323WH	2-ft Hook Cross Tee	White		24-in	1 1/2-in	15/16-in	60	120
	ML7323BL	2-ft Hook Cross Tee	Black		24-in	1 1/2-in	15/16-in	60	120
	7800RWH	12-ft Wall Molding	White		144-in	7/8-in	7/8-in	30	360
	7800BL	12-ft Wall Molding	Black		144-in	7/8-in	7/8-in	30	360
	6366	QuickHang™ 6-in Grid Hook Kits – Master Cartons *For residential use only	—					See details on page 41	
	6368	QuickHang™ 12-in Grid Hook Kits – Master Cartons *For residential use only	—					See details on page 41	
	7891	12 Gauge Hanger Wire			144-in			140	



**UL Fire-Rated Assembly – Prelude® 15/16-in Grid System** NOTE: use with 915 Fire Guard™ Textured Ceiling Panels  
 For use in spaces in which an hourly rating is needed to meet code requirements.

Cross Section Illustration	Prelude Item #	Product Name	Color	LBS/LF on 4-ft span	Length	Web Height	Flange Width	PC/CTN	LF/CTN
	<b>8300XRWH</b>	Fire Guard™ 12-ft Intermediate Duty Main Beam	White	12.8	144-in	1 11/16-in	15/16-in	20	240
	<b>8300BL</b>	Fire Guard™ 12-ft Intermediate Duty Main Beam	Black	12.8	144-in	1 11/16-in	15/16-in	20	240
	<b>XL8340RWH</b>	4-ft Stab Cross Tee	White		48-in	1 11/16-in	15/16-in	60	240
	<b>XL8340BL</b>	4-ft Stab Cross Tee	Black		48-in	1 11/16-in	15/16-in	60	240
	<b>XL8323RWH</b>	2-ft Stab Cross Tee	White		24-in	1 3/8-in	15/16-in	60	120
	<b>XL8323BL</b>	2-ft Stab Cross Tee	Black		24-in	1 3/8-in	15/16-in	60	120
	<b>7800RWH</b>	12-ft Wall Molding	White		144-in	7/8-in	7/8-in	30	360
	<b>7800BL</b>	12-ft Wall Molding	Black		144-in	7/8-in	7/8-in	30	360
	<b>7891</b>	12 Gauge Hanger Wire			144-in			140	

NOTE: Must be installed according to directions and no product substitutions.



915 TEXTURED FIRE GUARD™ (CEILING)

## Heavy Duty – Prelude® 15/16-in Grid System

Cross Section Illustration	Prelude Item #	Product Name	Color	LBS/LF on 4-ft span	Length	Web Height	Flange Width	PC/CTN	LF/CTN
	7301WH	12-ft Heavy Duty Main Beam	White	16.5	144-in	1 11/16-in	15/16-in	20	240
	7301BL	12-ft Heavy Duty Main Beam	Black	16.5	144-in	1 11/16-in	15/16-in	20	240
	XL7342BL	4-ft Stab Cross Tee	Black		48-in	1 1/2-in	15/16-in	60	240
	XL7348RWH	4-ft Stab Cross Tee	White		48-in	1 3/8-in	15/16-in	60	240
	XL7328RWH	2-ft Stab Cross Tee	White		24-in	1 3/8-in	15/16-in	60	120
	XL7328BL	2-ft Stab Cross Tee	Black		24-in	1 3/8-in	15/16-in	60	120
	ML7343WH	4-ft Hook Cross Tee	White		48-in	1 1/2-in	15/16-in	60	240
	ML7343BL	4-ft Hook Cross Tee	Black		48-in	1 1/2-in	15/16-in	60	240
	ML7323WH	2-ft Hook Cross Tee	White		24-in	1 1/2-in	15/16-in	60	120
	ML7323BL	2-ft Hook Cross Tee	Black		24-in	1 1/2-in	15/16-in	60	120
	7800RWH	12-ft Wall Molding	White		144-in	7/8-in	7/8-in	30	360
	7800BL	12-ft Wall Molding	Black		144-in	7/8-in	7/8-in	30	360
	7891	12 Gauge Hanger Wire			144-in			140	



492 YUMA WHITE® (CEILING)





Suprafine® 9/16-in Grid System

Cross Section Illustration	Accessories Item #	Accessories Name	Color	LBS/LF on 4-ft span	Length	Web Height	Flange Width	PC/CTN	LF/CTN
	7500RWH	12-ft Intermediate Duty Main Beam	White	12.75	144-in	1 11/16-in	9/16-in	20	240
	XL7540RWH	4-ft Stab Cross Tee	White		48-in	1 11/16-in	9/16-in	60	240
	XL7520RWH	2-ft Stab Cross Tee	White		24-in	1 11/16-in	9/16-in	60	120
	7804RWH	12-ft Wall Molding	White		144-in	7/8-in	9/16-in	30	360
	6366	QuickHang™ 6-in Grid Hook Kits – Master Cartons <i>*For residential use only</i>	—		See details on page 41				
	6368	QuickHang™ 12-in Grid Hook Kits – Master Cartons <i>*For residential use only</i>	—		See details on page 41				
	7891	12 Gauge Hanger Wire			144-in			140	

Pictured: 276 Sahara™ in narrow 9/16-in Suprafine® grid.



276 SAHARA™ (CEILING)

# SUSPENDED (DROP) CEILING INSTALLATION SYSTEMS ACCESSORIES

Clips help with installations, making transitions easier, aiding with squareness, and ensuring building requirements are met.

## Prelude® 15/16-in Grid System Accessories

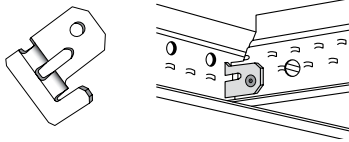
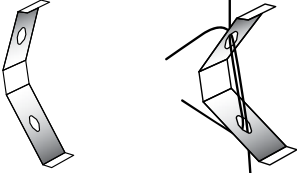
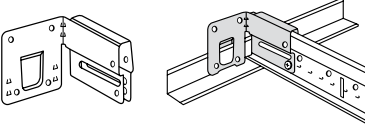
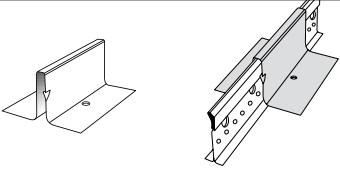
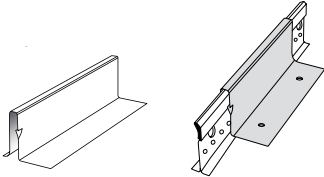
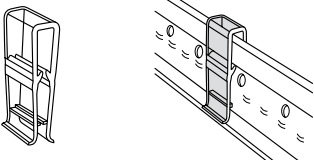
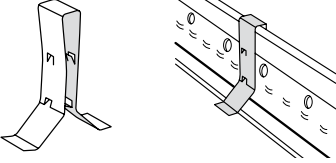
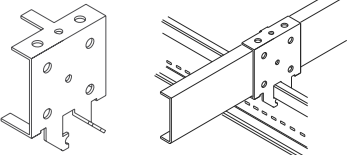
Cross Section Illustration	Item #	Product Name	Weight (lbs) per carton	PC/CTN
	FZSTAC	Single Tee Adapter Clip	1.50	50
	FZWS12A	Wire Splice	1.00	50
	FZBERC2	2-in Beam End Retaining Clip	5.00	50
	BERC2	2-in Beam End Retaining Clip	34.00	200
	MBACAG	Main Beam Adapter Clip	11.00	70
	FZDWACSAG	Drywall Attachment Clip	4.00	50
	FZCHDC	Clear Hold Down Clip (Recommended for use with Easy Elegance™ ceiling panels)	0.50	50
	FZUHDCA	Universal Hold Down Clip	0.50	50
	UHDCA	Universal Hold Down Clip	9.00	1000
	UTCA	Up Tight Clip (to attach to wood joist)	16.00	250

# SUSPENDED CEILING ESTIMATING GUIDE

## FOR CEILING PANELS AND GRID

Instructions: Find room size on left and read across for 24-in x 24-in or 24-in x 48-in ceiling panels. As a general rule, use one, two-bulb 4-ft fluorescent lighting fixture every 75 square feet. Use one luminous panel for every recessed lighting fixture.

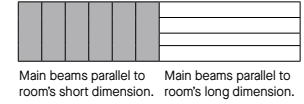

ROOM SIZE	AREA - SQ FT	12-ft WALL MOULDINGS	24-in x 24-in						24-in x 48-in				ROOM SIZE	AREA - SQ FT	12-ft WALL MOULDINGS	24-in x 24-in						24-in x 48-in														
			NUMBER OF PANELS	12-ft MAIN BEAMS	4-ft CROSS TEES	2-ft CROSS TEES	12-ft MAIN BEAMS	4-ft CROSS TEES	2-ft CROSS TEES	NUMBER OF PANELS	12-ft MAIN BEAMS	4-ft CROSS TEES				12-ft MAIN BEAMS	4-ft CROSS TEES	NUMBER OF PANELS	12-ft MAIN BEAMS	4-ft CROSS TEES	2-ft CROSS TEES	NUMBER OF PANELS	12-ft MAIN BEAMS	4-ft CROSS TEES	12-ft MAIN BEAMS	4-ft CROSS TEES										
6-ft x 6-ft to 10-ft x 48-ft Room Sizes													12-ft x 12-ft to 20-ft x 24-ft Room Sizes																							
6 x 6	36	2	9	1	2	5	1	2	5	6	1	4	1	4	12 x 12	144	4	36	2	15	18	2	15	18	18	2	15	2	15	18	18	2	15	2	15	18
6 x 8	48	3	12	1	4	6	1	3	7	8	1	6	1	6	12 x 14	168	5	42	3	15	23	3	18	21	21	3	17	3	18	21	21	3	17	3	18	
6 x 10	60	3	15	1	4	8	1	4	9	10	1	7	1	8	12 x 16	192	5	48	3	20	24	3	21	24	24	3	20	3	21	24	24	3	20	3	21	
6 x 12	72	3	18	1	6	9	1	5	11	12	1	9	1	10	12 x 18	216	5	54	4	20	29	3	24	27	27	4	22	3	24	27	27	4	22	3	24	
6 x 14	84	4	21	2	6	11	2	6	13	14	2	10	2	12	12 x 20	240	6	60	4	25	30	4	27	30	30	4	25	4	27	30	30	4	25	4	27	
6 x 18	108	4	27	2	8	14	2	8	17	18	2	13	2	16	12 x 24	288	6	72	5	30	36	4	33	36	36	5	30	4	33	36	36	5	30	4	33	
6 x 22	132	5	33	3	10	17	2	10	21	22	3	16	2	20	12 x 28	336	7	84	6	35	42	5	39	42	42	6	35	5	39	42	42	6	35	5	39	
6 x 26	156	6	39	3	12	20	3	12	25	26	3	19	3	24	12 x 32	384	8	96	7	40	48	6	45	48	48	7	40	6	45	48	48	7	40	6	45	
6 x 30	180	6	45	4	14	23	3	14	29	30	4	22	3	28	12 x 36	432	8	108	8	45	54	6	51	54	54	8	45	6	51	54	54	8	45	6	51	
6 x 34	204	7	51	4	16	26	3	16	33	34	4	25	3	32	12 x 40	480	9	120	9	50	60	7	57	60	60	9	50	7	57	60	60	9	50	7	57	
6 x 38	228	8	57	5	18	29	4	18	37	38	5	28	4	36	12 x 44	528	10	132	10	55	66	8	63	66	66	10	55	8	63	66	66	10	55	8	63	
6 x 42	252	8	63	5	20	32	4	20	41	42	5	31	4	40	12 x 48	576	10	144	11	60	72	8	69	72	72	11	60	8	69	72	72	11	60	8	69	
6 x 46	276	9	69	6	22	35	4	22	45	46	6	34	4	44	12 x 50	600	11	150	12	60	77	9	72	75	75	12	62	9	72	75	75	12	62	9	72	
6 x 50	300	10	75	6	24	38	5	24	49	50	6	37	5	48	14 x 14	196	5	56	4	18	27	4	18	27	27	4	24	4	24	27	27	4	24	4	24	
8 x 8	64	3	16	1	6	8	1	6	8	8	1	6	1	6	14 x 16	224	5	63	4	18	28	4	21	31	31	4	28	4	28	31	31	4	28	4	28	
8 x 10	80	3	20	2	6	11	1	8	10	10	2	7	1	8	14 x 18	252	6	70	5	24	34	5	24	35	35	5	31	5	32	35	35	5	31	5	32	
8 x 12	96	4	24	2	9	12	1	10	12	12	2	9	1	10	14 x 20	280	6	77	5	24	35	5	27	39	39	5	35	5	36	39	39	5	35	5	36	
8 x 14	112	4	28	2	9	15	2	12	14	14	2	10	2	12	14 x 22	308	6	84	6	30	41	6	31	43	43	6	38	6	40	43	43	6	38	6	40	
8 x 16	128	4	32	2	12	16	2	14	16	16	2	12	2	14	14 x 26	364	7	98	7	36	48	7	37	51	51	7	45	7	48	51	51	7	45	7	48	
8 x 18	144	5	36	3	12	19	2	16	18	18	3	13	2	16	14 x 30	420	8	112	9	42	55	8	43	59	59	8	52	8	56	59	59	8	52	8	56	
8 x 20	160	5	40	3	15	20	2	18	20	20	3	15	2	18	14 x 34	476	8	126	10	48	62	9	49	67	67	9	59	9	64	67	67	9	59	9	64	
8 x 22	176	5	44	4	15	23	2	20	22	22	4	16	2	20	14 x 38	532	9	140	11	54	69	10	55	75	75	10	66	10	72	75	75	10	66	10	72	
8 x 26	208	6	52	4	18	27	3	24	26	26	4	19	3	24	14 x 42	588	10	154	12	60	76	11	61	83	83	11	74	11	80	83	83	11	74	11	80	
8 x 30	240	7	60	5	21	31	3	28	30	30	5	22	3	28	14 x 46	644	10	168	13	66	83	12	67	91	91	12	81	12	88	91	91	12	81	12	88	
8 x 34	272	7	68	6	24	35	3	32	34	34	6	25	3	32	14 x 50	700	11	182	14	72	90	13	73	99	99	13	88	13	96	99	99	13	88	13	96	
8 x 38	304	8	76	6	27	39	4	36	38	38	6	28	4	36	16 x 18	288	6	72	6	28	39	5	36	40	40	6	31	5	32	40	40	6	31	5	32	
8 x 42	336	9	84	7	30	43	4	40	42	42	7	31	4	40	16 x 22	352	7	88	7	35	47	6	44	48	48	7	38	6	40	48	48	7	38	6	40	
8 x 46	368	9	92	8	33	47	4	44	46	46	8	34	4	44	16 x 26	416	7	104	8	42	55	7	52	56	56	8	45	7	48	56	56	8	45	7	48	
8 x 50	400	10	100	8	36	51	5	48	50	50	8	37	5	48	16 x 30	480	8	120	10	49	63	8	60	64	64	10	52	8	56	64	64	10	52	8	56	
10 x 10	100	4	25	2	8	14	2	8	14	14	2	12	2	12	16 x 34	544	9	136	11	56	71	9	68	72	72	11	59	9	64	72	72	11	59	9	64	
10 x 12	120	4	30	2	12	15	2	10	17	17	2	15	2	15	16 x 38	608	9	152	12	63	79	10	76	80	80	12	66	10	72	80	80	12	66	10	72	
10 x 14	140	4	35	3	12	19	3	12	20	20	3	17	3	18	16 x 42	672	10	168	14	70	87	11	84	88	88	14	74	11	80	88	88	14	74	11	80	
10 x 16	160	5	40	3	16	20	3	14	23	23	3	20	3	21	16 x 46	736	11	184	15	77	95	12	92	96	96	15	81	12	88	96	96	15	81	12	88	
10 x 18	180	5	45	4	16	24	3	16	26	26	4	22	3	24	16 x 50	800	11	200	16	84	103	13	100	104	104	16	88	13	96	104	104	16	88	13	96	
10 x 20	200	5	50	4	20	25	4	18	29	29	4	25	4	27	18 x 20	360	7	90	6	32	45	7	36	49	49	6	45	7	45	49	49	6	45	7	45	
10 x 22	220	6	55	5	20	29	4	20	32	32	5	27	4	30	18 x 24	432	7	108	8	40	54	8	44	59	59	8	54	8	55	59	59	8	54	8	55	
10 x 24	240	6	60	5	24	30	4	22	35	35	5	30	4	33	18 x 28	504	8	126	9	48	63	10	52	69	69	9	63	10	65	69	69	9	63	10	65	
10 x 26	260	6	65	5	24	34	5	24	38	38	5	32	5	36	18 x 32	576	9	144	11	56	72	11	60	79	79	11	72	11	75	79	79	11	72	11	75	
10 x 28	280	7	70	5	28	35	5	26	41	41	5	35	5	39	18 x 36	648	9	162	12	64	81	12	68	89	89	12	81	12	85	89	89	12	81	12	85	
10 x 32	320	7	80	6	32	40	6	30	47	47	6	40	6	45	18 x 40	720	10	180	14	72	90	14	76	99	99	14	90	14	95	99	99	14	90	14	95	
10 x 36	360	8	90	7	36	45	6	34	53	53	7	45	6	51	18 x 44	792	11	198	15	80	99	15	84	109	109	15	99	15	105	109	109	15	99	15	105	
10 x 40	400	9	100	8	40	50	7	38	59	59	8	50	7	57	18 x 48	864	11	216	17	88	108	16	92	119	119	16	108	16	115	119	119	16	108	16	115	
10 x 44	440	9	110	9	44	55	8	42	65	65	9	55	8	63	20 x 20	400	7	100	7	45	50	7	45	50	50	7	45	7	45	50	50	7	45	7	45	
10 x 48	480	10	120	10	48	64	8	46	71	71	10	60	8	69	20 x 24	480	8	120	9	54	60	8	55	60	60	9	54	8	55	60	60	9	54	8	55	

For an online estimator and calculator, please visit

# DRYWALL GRID INSTALLATION SYSTEMS

## Drywall Grid Ceiling Framing System

Item Number	Item Name	Length	Face Dimension	Profile Height	Duty Load	Fire Rated	Routs	Load Test Data (Lbs/LF)						Perspective	Pcs/Ctn
								L/360 Simple Span			L/240 Simple Span				
HD8906	12-ft Main Beam	144-in	1-1/2-in	1-11/16-in	Heavy Duty	Yes	Routs 8-in O.C.	95.5	35.8	18.76	139.85	52.24	28.14		12
HD8906F08G	12-ft Main Beam	144-in	1-1/2-in	1-11/16-in	Heavy Duty	Yes	12-ft HD Drywall Main Beam – Faceted 8-in O.C.	-	-	12.3	-	-	18.4		12
XL8945P	4-ft CrossTee	48-in	1-1/2-in	1-1/2-in		Yes	9 routs – center rout and starting 10-in from each end			15.0			22.5		36
XL8926	2-ft CrossTee	24-in	1-1/2-in	1-1/2-in		Yes	3 routs – center rout and 10-in from each end	90.25			158				36

### Membrane Load Values

Component Combinations	Maximum Load in Lbs/SF at Hanger Wire/Cross Tee Spacing							
	48 / 24		48 / 16		36 / 16			
	Main	Tee	L/240	L/360	L/240	L/360		
HD8906 – XL8945P			7.03	4.69	7.03	4.69	14.93	9.95

### ShortSpan® Drywall System (for spaces <12-ft wide)

Item Number	Length	Description	Face Dimension	Profile Height	O.C. Spacing	Load Test Data (Lbs/LF) L/240 per ASTM C 645				Perspective	Pcs/Ctn
						7-ft	8-ft	10-ft	12-ft		
S7712P	144-in	12-ft ShortSpan® Tee	1-1/2-in	1-1/2-in	16-ft	2.80	18.38*	9.54*	4.87*		12
SB12P	144-in	StrongBack™ Drywall Support Bar (Pre-engineered solutions to support spans over 6-ft or 7-ft)	-	2-in	24-ft	-	12.25*	6.36*	3.25*		12

\*Requires mid-span vertical support

### Membrane Load Values—ShortSpan® (Maximum Load in Lbs/SF (L/240 per ASTM C 645))

Item Number	Length	O.C. Spacing	4-ft Span (Lbs/SF)	5-ft Span (Lbs/SF)	6-ft Span (Lbs/SF)	7-ft Span (Lbs/SF)
S7712P	12-ft	16-in	18.38	9.97	4.87	2.80

Note: 5/8-in drywall weighs 2.4 Lbs/SF (tees installed 16-in or 24-in on center), 1/2-in drywall weighs 2.0 Lbs/SF (tees installed 16-in on center only)

### Wall Molding

Item Number	Length	Description	Profile	Perspective	Pcs/Ctn
LAM12A	144-in	Locking Angle Molding nominal 1-1/4-in x 1-1/4-in (for ShortSpan and QuikStix soffits)			20
KAM1510B	120-in	Knurled Angle Molding nominal 1-1/2-in x 1-1/2-in			10
KAM1512B	144-in	Knurled Angle Molding nominal 1-1/2-in x 1-1/2-in			10

### QuikStix™ Soffits

Item Number	Length	Description	Face Dimension	Profile Height	Perspective	Pcs/Ctn
QS612	120-in	QuikStix™ Soffits (knockouts 6-in O.C.) 10-ft x 1-1/2-in x 1-1/2-in	1-1/2-in	1-1/2-in		10

### QuikStix™ Soffit – Horizontal Soffit Span

QS612 Placement	12-in or 16-in (Lbs/LF)	24-in	36-in
16-in O.C.	18.69	12.46	5.75
24-in O.C.	12.46	8.63	3.83

## Estimating Material



Item number	Length	Pcs/Ctn	LF/Ctn	Lbs/Ctn	Area of ceiling completed by one carton							
					8-in O.C.	16-in O.C.	24-in O.C.	36-in O.C.	48-in O.C.	50-in O.C.	72-in O.C.	
DRYWALL GRID MAIN BEAM												
HD8906	144-in	12	144	48			288	432	576	600	864	sq. ft.
DRYWALL GRID 1-1/2-in FACE CROSS TEES												
XL8945P	48-in	36	144	46	96	192	288					sq. ft.

Item number	Length	Pcs/Ctn	LF/Ctn	Lbs/Ctn
DRYWALL ANGLE MOLDING				
KAM1510B	120-in		240	20
LAM12A	144-in		240	39

## Accessories

A variety of drywall grid accessories are available to provide problem-solving solutions that save time, labor and money.

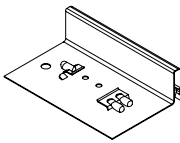
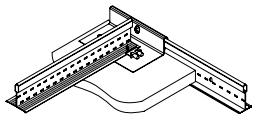
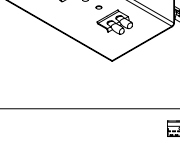
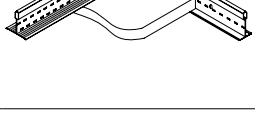
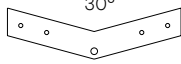
Item Number	Description	Perspective	Application	Pcs/Ctn
DW50LTR	DW50LTR – Unpainted Transition Clips for 1/2-in Drywall with Locking Tabs; facilitates transition from drywall to acoustical ceiling; one-sided hold-down clip; eliminates the need for a drywall bead. Locking tabs provide secure location for DGS tees. (12 pieces in a poly bag and 12 bags per box)			144
DW58LTR	DW58LTR – Unpainted Transition Clips for 5/8-in Drywall with Locking Tabs; facilitates transition from drywall to acoustical ceiling; one-sided hold-down clip; eliminates need for drywall bead. Locking tabs provide secure location for Drywall Grid Systems tees.			125
DW30CAG	30 Degree Unpainted Drywall Angle Clips are used to create positive and secure angles for drywall and ceiling installations on either main beams or cross tees			250
DW45CAG	45 Degree Unpainted Drywall Angle Clips are used to create positive and secure angles for drywall and ceiling installations on either main beams or cross tees			250
DW60CAG	60 Degree Unpainted Drywall Angle Clips are used to create positive and secure angles for drywall and ceiling installations on either main beams or cross tees			250
DW90CAG	90 Degree Unpainted Drywall Angle Clips are used to create positive and secure angles for drywall and ceiling installations on either main beams or cross tees			250
QSUTCR	Unpainted QuikStix™ Uptight Clips 4-1/2-in x 1-1/2-in x 1 3/4-in (G90 Hot Dipped/12 pieces in a poly bag and 12 bags per box)			144
RC2R	Unpainted Radius Clips are used for drywall applications which form curved installations; attaches to the cavity side of web of the main beam with four 7/16-in pan head screws; install at all knockout locations			205

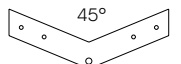
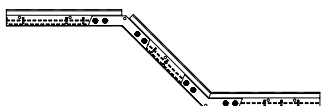
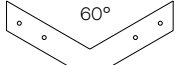
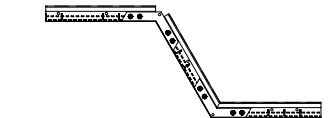
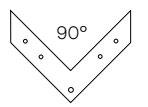
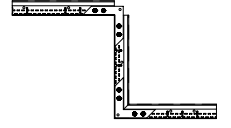
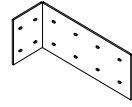
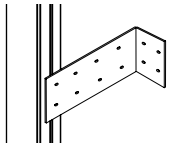
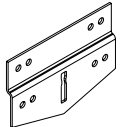
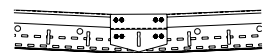
Visit both [ceilings.com/canada](http://ceilings.com/canada) and [ceilings.com/dealertools](http://ceilings.com/dealertools) for additional information and grid installation videos.

For the Easy Calculation of weight for your Grid Order, visit the **Grid Weight Estimator**, found on [ceilings.com/dealertools](http://ceilings.com/dealertools).

# SURFACE MOUNT (DIRECT APPLY) CEILING INSTALLATION

- Want to hide stains or an ugly popcorn ceiling?
- Want to maximize your ceiling height?
- Don't like the look of grid?

Surface Mount (Direct Apply) ceiling tiles or planks install quickly and easily with Easy Up® installation system.

**EasyUP**<sup>®</sup>  
INSTALLATION SYSTEM



1 Attach tracks (1190)



2 Snap on clips (1191 or 1191SC)



3 Position tile or plank; slide and secure clip



## Easy Up® Tracks

Item #1190  
(20 tracks per carton)

## Easy Up® Clips

Item #1191  
(360 clips per carton—  
8 bags of 45 each)

Item #1191SC  
(135 clips per carton)



WoodHaven™ plank installation using Easy Up® tracks and clips

*NOTE: Both track products and clip accessories are required for a complete Easy Up system and must be used together. Items are sold separately.*

Surface Mount (Direct Apply) products can also be installed with adhesive such as Henry® 237 AcoustiGum™ Acoustical Ceiling Tile Adhesive. Follow adhesive manufacturer's instructions for application and usage.

Henry and AcoustiGum are trademarks of W.W. Henry Company or its Affiliates.

# EASY UP® INSTALLATION SYSTEM

## FOR DIRECT APPLY CEILING TILES AND PLANKS

**EasyUP®**  
INSTALLATION SYSTEM

INSTALLATION



SURFACE MOUNT (DIRECT APPLY) CEILING

- Provides greater dimensional stability and strength versus wood furring
- Eliminates tile lipping caused by warping wood furring
- Easy Up® clips provide superior holding versus traditional staples
- Easy Up clips may be able to be used on an existing 15/16-in grid ceiling to install WoodHaven™ planks and Easy Elegance™ Woodgrain White planks
- Best method for installing planks over popcorn ceilings

### CALCULATE TRACKS AND CLIPS NEEDED

#### How to calculate tracks and clips needed:

#### Example:

1	Find your ceiling product on the below chart	12-in × 12-in Tile
2	Calculate the square footage of your room	10-ft wide × 12-ft long room = 120 sf
3	Find the Track Ratio listed for your ceiling product on the chart	1.10-lf of Track/sf
4	Multiply the sf by the ratio	120 sf × 1.10 = 132 lf
5	Divide the result by 8-ft for total number of tracks required. Round up if necessary	132 lf/8-ft = 16.5 (17 Tracks) (each track = 8-ft length)
6	Find the Clip Ratio listed for your ceiling product on the chart	1.3 Clips/sf
7	Multiply the sf from step 2 by the ratio	120 sf × 1.3 = 156 Clips
8	Round up if necessary for total number of clips required	156 Clips

*Notes: Table averages values of room combinations from 10-ft × 10-ft to 30-ft × 30-ft. It is possible that these values could leave you slightly short, as it is an average. Values assume butting Track joints, end to end, with no overlap.*

Ceiling product	Track spacing	Ratio of lf of Track/sf of room	Ratio of Clips/sf of room
12-in x 12-in Tile	12-in oc	1.10	1.30
Country Classic™ Plank	12-in oc	1.10	1.25
WoodHaven™	24-in oc	0.65	1.20
Easy Elegance™ Plank	16-in oc	0.80	2.00

oc = on center, lf = linear feet, sf = square feet

Please visit [ceilings.com/projectestimatorca](http://ceilings.com/projectestimatorca) to access our online material estimator.

Download a copy of the Easy Up® Installation System Estimating Guide at [ceilings.com/estimateeasyupca](http://ceilings.com/estimateeasyupca).



250 PINEHURST™ (CEILING)

# WOODHAVEN™ PLANK CEILING INSTALLATION OPTIONS

## INSTALL ON CEILINGS IN THREE DIFFERENT WAYS

Before starting your project, review complete installation instructions at [ceilings.com/installwoodhavenca](http://ceilings.com/installwoodhavenca) for important design and installation considerations.

### 1 WOODHAVEN™ CLIPS AND SCREWS



Installation clips and screws (55 each) are included in the plank package and install directly to furring strips (sold separately). This installation method is suitable for ceilings with a greater than 10 degree slope. Please contact Techline at 1-877-ARMSTRONG (276-7876) for guidance on how to install planks on a sloped ceiling.

### 2 EASY UP® TRACKS AND CLIPS



The Easy Up® installation system is fast and easy with snap-on (vs. screw-in) clips, and is the recommended method to install planks over drywall, plaster or popcorn ceilings. Use the Easy Up® installation system for ceilings with a less than 10 degree slope.

Item #1190 (20 tracks per carton)  
Item #1191 (360 clips per carton—8 bags of 45 each)  
or Item #1191SC (135 clips per carton)

NOTE: Both track products and clip accessories are required for a complete Easy Up system and must be used together. Items are sold separately.

### 3 INSTALLATION STEPS TO RETROFIT 15/16-in GRID

Transform an existing 15/16-in suspended (drop) ceiling using Easy Up® clips and WoodHaven™ planks.



Remove panels



Snap on Easy Up clips

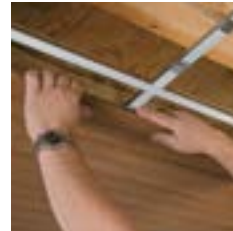

Position planks; slide and secure clips

*NOTE: Existing grid must be 15/16-in. Easy Up clips (sold separately) must be used for the retrofit installation. Screws and clips included in the WoodHaven package are only used where grid intersections interfere with the installation of an Easy Up clip.*

Visit [ceilings.com/canada](http://ceilings.com/canada) to order a sample Easy Up clip to test your grid for a snug fit.

Visit [ceilings.com/installwoodhavenca](http://ceilings.com/installwoodhavenca) for full installation instructions and tips.

Visit [ceilings.com/projectestimator](http://ceilings.com/projectestimator) to access our online material estimator.



Visit [ceilings.com/videosca](http://ceilings.com/videosca) to view WoodHaven installation videos for ceiling and wall applications.

### DESIGN/SPACE CONSIDERATIONS

- Material needs 2-3 days to acclimate to room conditions
- In ceiling applications, do not attach planks directly to roof structures, molding or walls
- Long runs of 21-ft or more require expansion joints

**WoodHaven™**  
CEILING & WALL PLANKS



## PRODUCT COMPARISON DATA

Armstrong Ceilings Retail	CGC Retail	CGC Commercial	CertainTeed Commercial
231 Washable White	4290 Custom White	None	None
241 SuperTuff™	None	5899 Touchstone	None
258 Grenoble™	4240 Tivoli	None	None
266 Brighton™	1004 Alpine	None	None
269 Sand Pebble™	R4800 Moonscape	4805 Pebbled	BET-154 Baroque
271 Sahara™	5221 Majestic	4221 Olympia Micro	SHM-154 Sand Micro
273 Sahara™	None	4211 Olympia Micro	SHM-157 Sand Micro
276 Sahara™	None	4231 Olympia Micro	SHM-150 Sand Micro
280 Plain White	380 Stonehurst	None	None
403 Esprit® Fiberglass	209 Tabaret	None	None
410 Random Fissured™	None	7053G Premier Hi-Lite	1530-VIN-1 Versatone
490 Yuma White®	None	62156 Orion	None
491 Yuma White®	None	62157 Orion	None
915 Textured FIRE GUARD™	220 Fifth Avenue	586 Fissured	None
922 Fine Fissured™	R2410 Radar	2410 Radar	HHF-197 Fine Fissured
928 Fine Fissured™	None	2210 Radar	HHF-157 Fine Fissured
932 Fine Fissured™	R2220 Radar	2220 Radar	HHF-154 Fine Fissured
933 Random Textured	R2310 Radar	2310 Radar	BET-197 Baroque
934 Random Textured	R2120 Radar	2120 Radar	BET-154 Baroque
935 Random Textured	R2110 Radar	2110 Radar	BET-157 Baroque
942 Textured	280 Fifth Avenue	562 Fissured	DMRF-197 Directional Fissured
949 Textured	133 Fifth Avenue	560 Fissured	DMRF-157 Directional Fissured
954 Classic Fine Textured	R76775 Luna	76775 Eclipse	CM-454 Cashmere®
972 Lumawash®	R3270 Sheetrock®	R3270 Sheetrock®	1140-CRF-1 Vinylrock
973 Lumawash®	R3260 Sheetrock®	R3260 Sheetrock®	1142-CRF-1 Vinylrock
9767 Scored	R2742 Radar Illusion	2742 Radar Illusion	BGCL-224 Baroque Customline®
9768 Sahara™ Scored II	None	4742 Olympia Micro Illusion	None

Note: This product comparison list is intended as a guide and is not meant to represent that products within the same category are identical substitutes. Please consult Manufacturer's Catalogs for specific technical data and U.L. designs required.

Brighton, Esprit, Fine Fissured, Fire Guard, Grenoble, Lumawash, Random Fissured, Sahara, Sand Pebble, SuperTuff, and Yuma White are trademarks or registered trademarks of AWI Licensing LLC and/or its affiliates in the U.S.A. and/or other countries.

All other registered trademarks are property of their respective owners.

# PERFORMANCE AND INSTALLATION METHOD GUIDE BY ITEM

Retail Item #	Retail Item Name	Page #	Size (Inches)	Edge Detail	Installation Method**	Fire Class	Sag Resistance	Mold/Mildew Resistance	NRC	CAC	LR	Recycled Material Content
46	Wellington™	35	12 × 12 × 1/2	Square Tongue & Groove	Surface Mount (Direct Apply)	A	Standard	Standard	—	30	0.76	40%
231	Washable White	36	12 × 12 × 1/2	Beveled Tongue & Groove	Surface Mount (Direct Apply)	A	Standard	Standard	—	30	0.80	24%
241	SuperTuff™	27	24 × 24 × 5/8	Tegular	Suspended (Drop)	A	Superior	Superior	0.50	33	0.86	33%
250	Pinehurst™	36	12 × 12 × 1/2	Beveled Tongue & Groove	Surface Mount (Direct Apply)	A	Standard	Standard	—	30	0.80	24%
257	Sand Pebble™	36	12 × 12 × 1/2	Beveled Tongue & Groove	Surface Mount (Direct Apply)	A	Standard	Standard	—	30	0.80	24%
258	Grenoble™	36	12 × 12 × 1/2	Beveled Tongue & Groove	Surface Mount (Direct Apply)	A	Standard	Standard	—	30	0.80	24%
266	Brighton™	27	24 × 24 × 1/2	Tegular	Suspended (Drop)	A	Standard	Superior	0.45	30	0.86	25%
269	Sand Pebble™	21	24 × 24 × 5/8	Tegular	Suspended (Drop)	A	Superior	Superior	0.55	30	0.80	41%
271	Sahara™	21	24 × 24 × 5/8	Tegular	Suspended (Drop)	A	Superior	Superior	0.50	35	0.81	41%
273	Sahara	21	24 × 24 × 5/8	Square	Suspended (Drop)	A	Superior	Superior	0.50	35	0.81	41%
276	Sahara	21	24 × 24 × 5/8	Tegular	9/16-in Suspended (Drop)	A	Superior	Superior	0.50	35	0.81	41%
280	Plain White	23	24 × 48 × 1/2	Square	Suspended (Drop)	A	Standard	Standard	—	30	0.80	24%
292	Zephyr*	21	24 × 48 × 1/2	Square	Suspended (Drop)	A	Superior	Superior	—	30	0.87	33%
297	Grenoble™	29	24 × 48 × 1/2	Square	Suspended (Drop)	A	Standard	Standard	—	30	0.80	24%
403	Esprit*	32	24 × 48 × 5/8	Square	Suspended (Drop)	A	Superior	Superior	0.55	—	0.72	82%
404	Pebble™	32	24 × 48 × 5/8	Square	Suspended (Drop)	A	Superior	Superior	0.50	—	0.85	82%
410	Sonoflex™ Random Fissured™	32	24 × 48 × 5/8	Square	Suspended (Drop)	A	Superior	Superior	0.55	—	0.72	82%
416	Sonoflex Etched	32	24 × 48 × 5/8	Square	Suspended (Drop)	A	Superior	Superior	0.55	—	0.72	82%
480	Country Classic™ Plank White	9	6 × 48 × 1/2	Beveled Tongue & Groove	Surface Mount (Direct Apply)	A	Standard	Standard	—	30	0.80	22%
Various	Country Classic Plank	9	6 × 48 × 1/2	Beveled Tongue & Groove	Surface Mount (Direct Apply)	A	Standard	Standard	—	30	—	22%
490	Yuma White*	21	24 × 24 × 5/8	Square	Suspended (Drop)	A	Superior	Superior	0.55	35	0.80	44%
491	Yuma White	23	24 × 48 × 5/8	Square	Suspended (Drop)	A	Superior	Superior	0.55	35	0.80	44%
492	Yuma White	21	24 × 24 × 5/8	Tegular	Suspended (Drop)	A	Superior	Superior	0.55	35	0.80	44%
493	Yuma White	23	24 × 48 × 5/8	Tegular	Suspended (Drop)	A	Superior	Superior	0.55	35	0.80	44%
902	Textured	29	24 × 48 × 1/2	Square	Suspended (Drop)	A	Standard	Standard	0.45	—	0.79	30%
915*	Textured FIRE GUARD™	29	24 × 48 × 5/8	Square	Suspended (Drop)	A	Standard	Standard	0.55	35	0.79	38%
922	Fine Fissured™	29	24 × 48 × 5/8	Square	Suspended (Drop)	A	Superior	Superior	0.55	35	0.82	40%
928	Fine Fissured	27	24 × 24 × 5/8	Square	Suspended (Drop)	A	Superior	Superior	0.55	33	0.82	40%
932	Fine Fissured	27	24 × 24 × 5/8	Tegular	Suspended (Drop)	A	Superior	Superior	0.55	35	0.82	40%
933	Random Textured	29	24 × 48 × 5/8	Square	Suspended (Drop)	A	Standard	Standard	0.55	35	0.80	30%
934	Random Textured	27	24 × 24 × 5/8	Tegular	Suspended (Drop)	A	Standard	Standard	0.55	33	0.80	30%
935	Random Textured	27	24 × 24 × 5/8	Square	Suspended (Drop)	A	Standard	Standard	0.55	33	0.80	30%
942	Textured	30	24 × 48 × 5/8	Square	Suspended (Drop)	A	Standard	Standard	0.55	30	0.79	30%
949	Textured	27	24 × 24 × 5/8	Square	Suspended (Drop)	A	Standard	Standard	0.55	33	0.79	30%
954	Classic Fine Textured	27	24 × 24 × 3/4	Tegular	Suspended (Drop)	A	Superior	Superior	0.70	35	0.85	67%
972	Lumawash*	23	24 × 48 × 5/8	Square	Suspended (Drop)	A	Superior	Superior	—	33	0.89	36%
973	Lumawash	21	24 × 24 × 5/8	Square	Suspended (Drop)	A	Superior	Superior	—	33	0.89	36%
1132	Baltic™	36	12 × 12 × 1/2	Beveled Tongue & Groove	Surface Mount (Direct Apply)	A	Standard	Standard	—	30	0.80	24%
1133	Baltic	30	24 × 48 × 1/2	Square	Suspended (Drop)	A	Standard	Standard	—	30	0.80	24%
1148	WoodHaven Painted White	4, 7	5 × 84 × 3/8	Beveled Tongue & Groove	Surface Mount (Direct Apply)	C	Standard	Standard	—	—	0.85	95%
1149	WoodHaven Beadboard	4, 7	5 × 84 × 3/8	Beveled Tongue & Groove	Surface Mount (Direct Apply)	C	Standard	Standard	—	—	0.85	95%
Various	WoodHaven	4, 7	5 × 84 × 3/8	Beveled Tongue & Groove	Surface Mount (Direct Apply)	C	Standard	Standard	—	—	—	95%
1201	Raised Panel™	18	24 × 24 × 5/8	Tegular	Suspended (Drop)	A	Standard	Standard	—	30	0.78	52%
1202	Scalloped	18	24 × 24 × 5/8	Tegular	Suspended (Drop)	A	Standard	Standard	—	30	0.78	52%
1203	Fluted	18	24 × 24 × 5/8	Tegular	Suspended (Drop)	A	Standard	Standard	—	30	0.78	52%
1205	Single Raised Panel	18	24 × 24 × 5/8	Tegular	Suspended (Drop)	A	Standard	Standard	—	30	0.78	52%
1206	Tango	18	24 × 24 × 5/8	Tegular	Suspended (Drop)	A	Standard	Standard	—	30	0.78	52%
1210	Single Raised Panel	18	24 × 24 × 3/4	Tegular	9/16-in Suspended (Drop)	A	Standard	Standard	—	30	0.78	52%
1231	Brightex™ with AirGuard™	21	24 × 24 × 3/4	Tegular	9/16-in Suspended (Drop)	A	Superior	Superior	0.65	35	0.88	55%
1240	TinTile™	35	12 × 12 × 1/2	Square Tongue & Groove	Surface Mount (Direct Apply)	A	Standard	Standard	—	30	0.80	40%
1244	Circles	35	12 × 12 × 1/2	Square Tongue & Groove	Surface Mount (Direct Apply)	A	Standard	Standard	—	30	0.80	40%
1270	Cascade*	18	24 × 24 × 3/4	Tegular	Suspended (Drop)	A	Standard	Standard	—	30	0.80	25%
Various	Easy Elegance™ Coffers	12	Various	Tegular	Suspended (Drop)	A	Superior	Superior	—	—	(V)	—
Various	Easy Elegance Flat Panels	13	Various	Square	Suspended (Drop)	A	Superior	Superior	—	—	(V)	—
Various	Easy Elegance Textured Panels	14	Various	Square	Suspended (Drop)	A	Superior	Superior	—	—	(V)	—
1293	Easy Elegance Plank Woodgrain White	16	6 × 48 × 1/3	Beveled Tongue & Groove	Surface Mount (Direct Apply)	A	Superior	Superior	—	—	0.90	—
1301	Non-Directional	30	24 × 48 × 1/2	Square	Suspended (Drop)	A	Standard	Standard	0.45	30	0.80	25%
1728BL	Fine Fissured-Black	27	24 × 24 × 5/8	Square	Suspended (Drop)	A	Superior	Superior	0.55	33	0.06	40%
2012WH	AcoustAffix™ White	38	24 × 48 × 3/4	Square/Reverse Tegular	Surface Mount (Direct Apply)	A	Superior	Superior	0.75	—	—	50%
2012BL	AcoustAffix Black	38	24 × 48 × 3/4	Square/Reverse Tegular	Surface Mount (Direct Apply)	A	Superior	Superior	0.75	—	—	50%
2012	AcoustAffix Field Paintable	38	24 × 48 × 3/4	Square	Surface Mount (Direct Apply)	A	Superior	Superior	0.75	—	—	50%
8008	TinCraft™ Circles	18	24 × 24 × 3/4	Tegular	Suspended (Drop)	A	Standard	Standard	—	35	0.78	52%
8009	TinCraft Squares	18	24 × 24 × 3/4	Tegular	9/16-in Suspended (Drop)	A	Standard	Standard	—	35	0.78	52%
9767	Scored	30	24 × 48 × 3/4	Tegular	Suspended (Drop)	A	Standard	Standard	0.55	35	0.82	29%
9768	Sahara™ Scored II	23	24 × 48 × 3/4	Tegular	Suspended (Drop)	A	Superior	Superior	0.50	35	0.81	43%
9769	Sahara™ Scored I	23	24 × 48 × 3/4	Tegular	Suspended (Drop)	A	Superior	Superior	0.50	35	0.81	43%

\* Fire Guard™: a fire resistive ceiling when used in applicable UL assemblies.

NOTE: Noise reduction coefficient (NRC), ceiling attenuation class (CAC), light reflectance (LR) and flame spread ratings are expressed according to ASTM E 1264 requirements.

† Fire Classes are U.S. designations. Contact Techline for information about CAN/ULC S102 testing.

\*\* Suspended (Drop) Ceilings install on 15/16-in Prelude™ grid unless otherwise specified.

# PACKAGING GUIDE BY ITEM

Retail Item #	Retail Item Name	Size (Inches)	Edge Detail	SF Per Ctn	Pcs/Ctn	Lbs/Ctn	Ctns Per Pallet	Layers Per Pallet	Warranty
46	Wellington™	12 × 12 × 1/2	Square Tongue & Groove	40	40	33	48	8	10/30-year
231	Washable White	12 × 12 × 1/2	Beveled Tongue & Groove	40	40	28	48	8	10/30-year
241	SuperTuff™	24 × 24 × 5/8	Tegular	48	12	52	40	10	10/30-year
250	Pinehurst™	12 × 12 × 1/2	Beveled Tongue & Groove	40	40	28	48	8	10/30-year
257	Sand Pebble™	12 × 12 × 1/2	Beveled Tongue & Groove	40	40	28	48	8	10/30-year
258	Grenoble™	12 × 12 × 1/2	Beveled Tongue & Groove	40	40	28	48	8	10/30-year
266	Brighton™	24 × 24 × 1/2	Tegular	64	16	43	40	10	1-year
269	Sand Pebble™	24 × 24 × 5/8	Tegular	64	16	43	36	9	10/30-year
271	Sahara™	24 × 24 × 5/8	Tegular	64	16	60	32	9	10/30-year
273	Sahara	24 × 24 × 5/8	Square	64	16	51	32	9	10/30-year
276	Sahara	24 × 24 × 5/8	Tegular	64	16	48	32	8	10/30-year
280	Plain White	24 × 48 × 1/2	Square	64	8	44	44	22	1-year
292	Zephyr™	24 × 24 × 5/8	Square	64	16	44	20	5	1-year
297	Grenoble	24 × 48 × 1/2	Square	64	8	44	44	22	1-year
403	Esprit™	24 × 48 × 5/8	Square	128	16	22	18	18	10/30-year
404	Pebble™	24 × 48 × 5/8	Square	128	16	22	18	18	10/30-year
410	Sonoflex™ Random Fissured™	24 × 48 × 5/8	Square	128	16	22	18	13	10/30-year
416	Sonoflex Etched	24 × 48 × 5/8	Square	128	16	22	18	9	10/30-year
Various	Country Classic™ Plank	6 × 48 × 1/2	Beveled Tongue & Groove	40	20	33	48	16	10/30-year
490	Yuma White™	24 × 24 × 5/8	Square	64	16	49	36	9	10/30-year
491	Yuma White	24 × 48 × 5/8	Square	64	8	49	36	18	10/30-year
492	Yuma White	24 × 24 × 5/8	Tegular	64	16	49	36	9	10/30-year
493	Yuma White	24 × 48 × 5/8	Tegular	64	8	49	34	17	10/30-year
902	Textured	24 × 48 × 1/2	Square	80	10	47	30	15	1-year
915	Textured FIRE GUARD™	24 × 48 × 5/8	Square	64	8	71	36	18	1-year
922	Fine Fissured™	24 × 48 × 5/8	Square	64	8	45	36	14	10/30-year
928	Fine Fissured	24 × 24 × 5/8	Square	64	16	45	36	9	10/30-year
932	Fine Fissured	24 × 24 × 5/8	Tegular	64	16	53	36	9	10/30-year
933	Random Textured	24 × 48 × 5/8	Square	80	10	53	30	15	1-year
934	Random Textured	24 × 24 × 5/8	Tegular	64	16	44	36	9	1-year
935	Random Textured	24 × 24 × 5/8	Square	64	16	41	36	9	1-year
942	Textured	24 × 48 × 5/8	Square	80	10	53	30	15	1-year
949	Textured	24 × 24 × 5/8	Square	64	16	41	36	9	1-year
954	Classic Fine Textured	24 × 24 × 3/4	Tegular	48	12	51	36	9	10/30-year
972	Lumawash™	24 × 48 × 5/8	Square	64	8	45	36	18	10/30-year
973	Lumawash	24 × 24 × 5/8	Square	64	16	44	36	9	10/30-year
1132	Baltic™	12 × 12 × 1/2	Beveled Tongue & Groove	40	40	27	48	8	10/30-year
1133	Baltic	24 × 48 × 1/2	Square	64	8	48	44	22	1-year
Various	WoodHaven™	5 × 84 × 3/8	Beveled Tongue & Groove	29	10	47	48	6	10-year
1201	Raised Panel™	24 × 24 × 5/8	Tegular	24	6	19	36	9	10-year
1202	Scalloped	24 × 24 × 5/8	Tegular	24	6	22	36	9	10-year
1203	Fluted	24 × 24 × 5/8	Tegular	24	6	22	36	9	10-year
1205	Single Raised Panel	24 × 24 × 5/8	Tegular	24	6	22	36	9	10-year
1206	Tango	24 × 24 × 5/8	Tegular	24	6	22	36	9	10-year
1210	Single Raised Panel	24 × 24 × 3/4	Tegular	24	6	22	36	9	10-year
1231	Brightex™ with AirGuard™	24 × 24 × 3/4	Tegular	32	8	35	56	14	10/30-year
1240	TinTile™	12 × 12 × 1/2	Square Tongue & Groove	40	40	33	48	8	10/30-year
1244	Circles	12 × 12 × 1/2	Square Tongue & Groove	40	40	35	48	8	10/30-year
1270	Cascade™	24 × 24 × 3/4	Tegular	48	12	37	40	10	1-year
Various	Easy Elegance™ Coffers	Various	Tegular	4	1	Various	Various	Various	Lifetime
Various	Easy Elegance Flat Panels	Various	Square	Various	Various	Various	Various	Various	Lifetime
Various	Easy Elegance Textured Panels	Various	Square	Various	Various	Various	Various	Various	Lifetime
1293	Easy Elegance Plank Woodgrain White	6 × 48 × 1/3	Beveled Tongue & Groove	20	10	15	72	12	Lifetime
1301	Non-Directional	24 × 48 × 1/2	Square	96	12	60	28	14	1-year
1728BL	Fine Fissured-Black	24 × 24 × 5/8	Square	64	16	52	36	9	10/30-year
2012WH	AcoustAffix™ White	24 × 48 × 3/4	Square/Reverse Tegular	48	6	52	36	18	5-year
2012BL	AcoustAffix Black	24 × 48 × 3/4	Square/Reverse Tegular	48	6	52	36	18	5-year
2012	AcoustAffix Field Paintable	24 × 48 × 3/4	Square	48	6	52	36	18	5-year
8008	TinCraft™ Circles	24 × 24 × 3/4	Tegular	48	12	43	40	10	1-year
8009	TinCraft Squares	24 × 24 × 3/4	Tegular	32	8	59	52	10	1-year
9767	Scored	24 × 48 × 3/4	Tegular	80	10	59	24	12	1-year
9768	Sahara™ Scored II	24 × 48 × 3/4	Tegular	64	8	56	24	12	10/30-year
9769	Sahara™ Scored I	24 × 48 × 3/4	Tegular	64	8	56	24	12	10/30-year



480 COUNTRY CLASSIC™ PLANK WHITE (CEILING)



1293 EASY ELEGANCE™ PLANK WOODGRAIN WHITE (WALL)

If you have ceiling or wall questions, call: **1-877-ARMSTRONG (276-7876)**

NOTE: Due to printing limitations, colors pictured cannot be guaranteed to match actual ceiling and wall materials.

Titebond® and GREENchoice are trademarks of Franklin International.

Henry® and AcoustiGum™ are trademarks of W.W. Henry Company or its Affiliates.

All other trademarks are property of AWI Licensing LLC or affiliates, or their respective owners.

©2023 AWI Licensing LLC

Printed in the United States of America

[ceilings.com/canada](https://ceilings.com/canada)



COVER PHOTO: 480MB COUNTRY CLASSIC™ PLANK MEDIUM BEIGE (CEILING)

**Armstrong®**  
World Industries